

2011-11-1

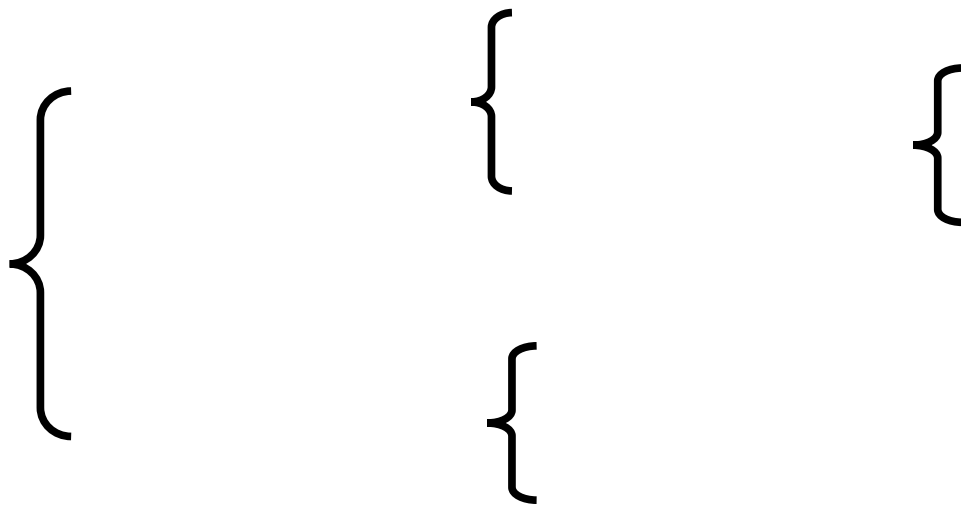



2011-11-1





2011-11-1

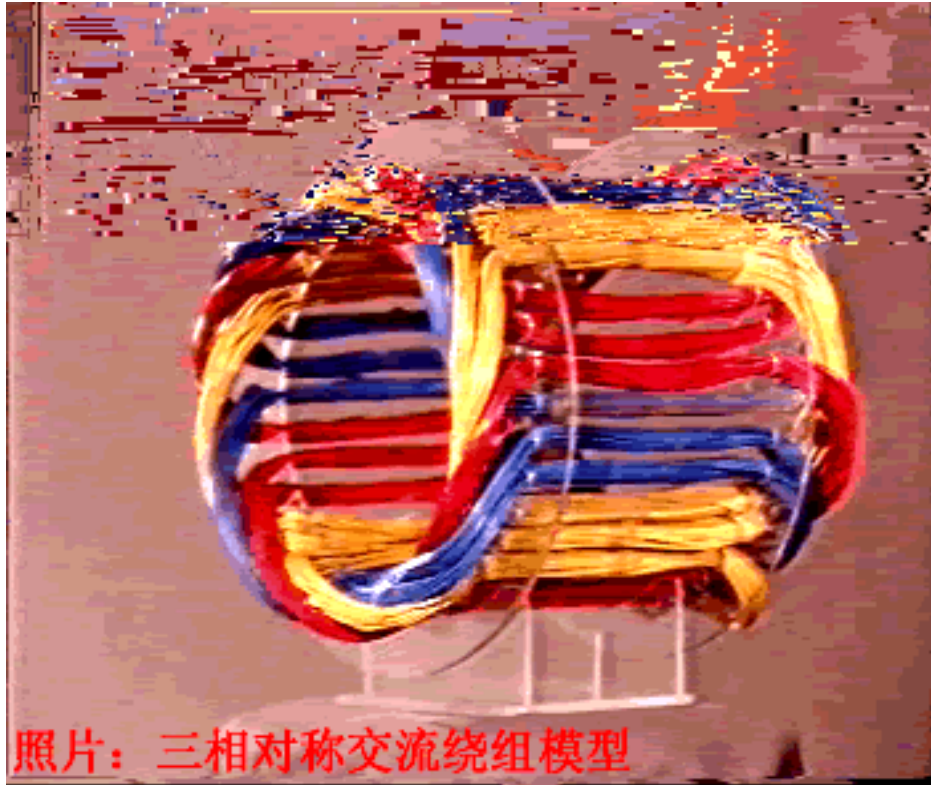

2011-11-1

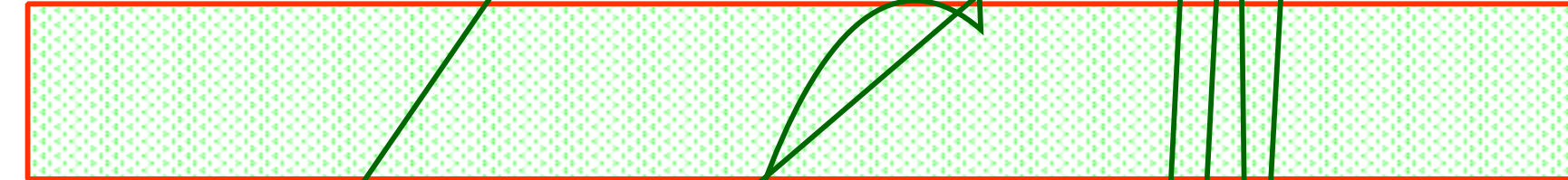
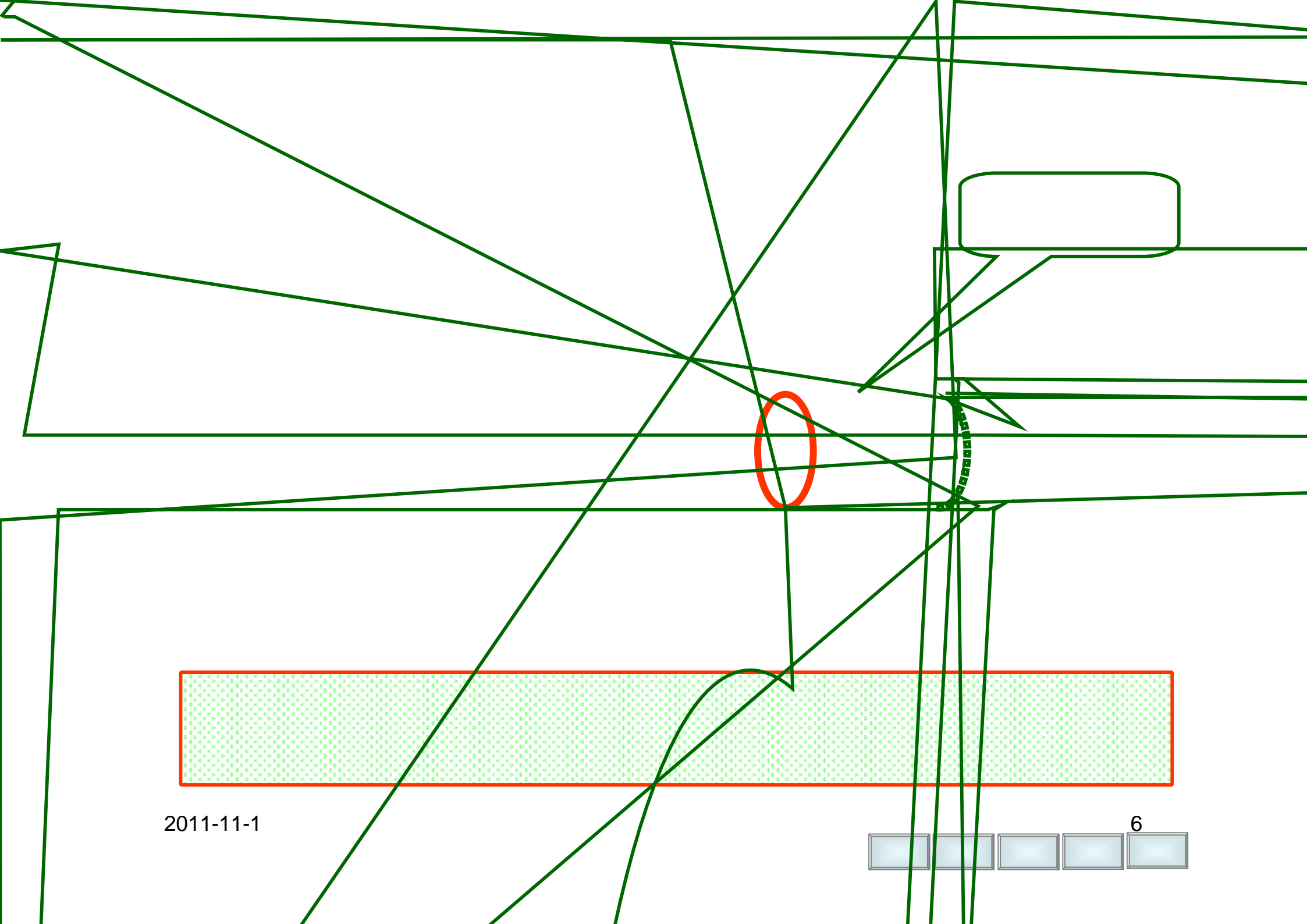

2011-11-1

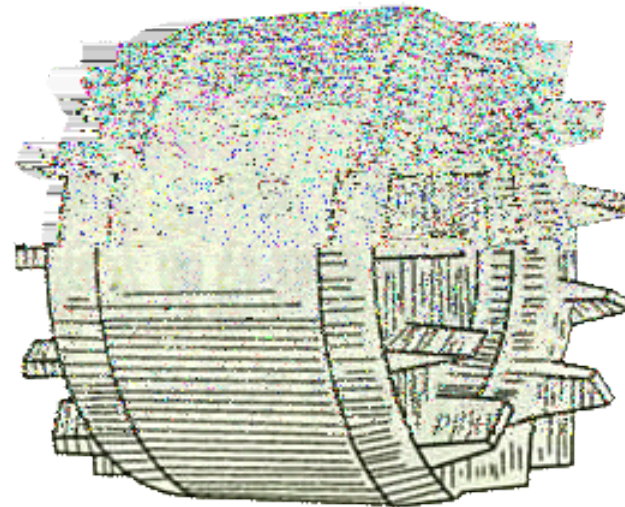
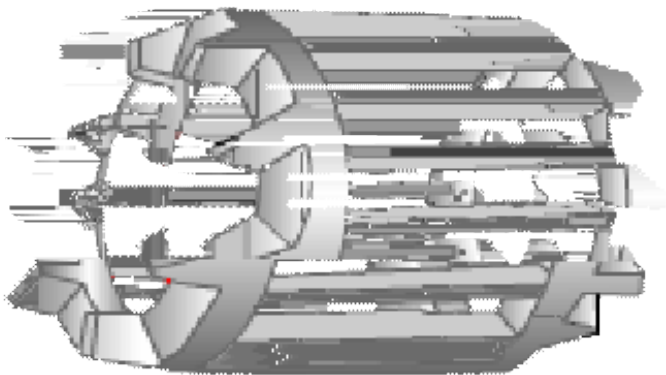
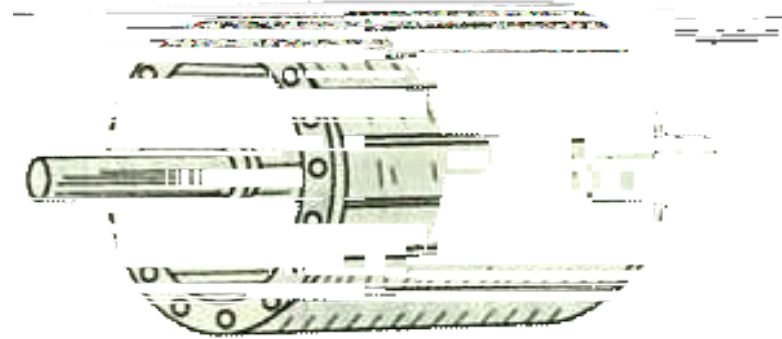
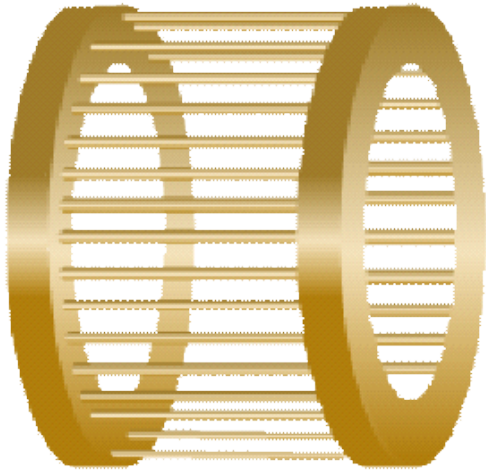

2011-11-1

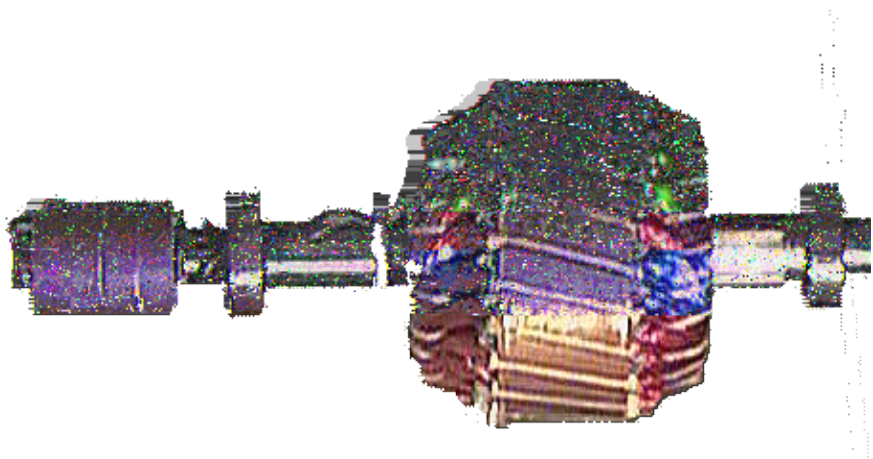
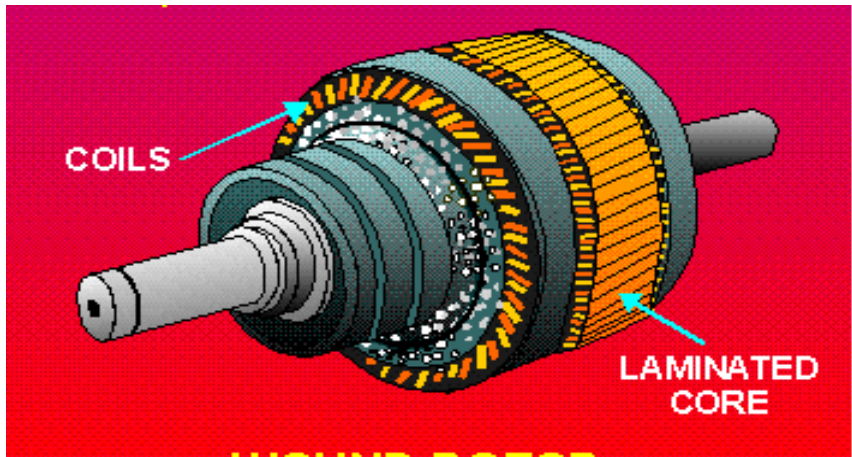
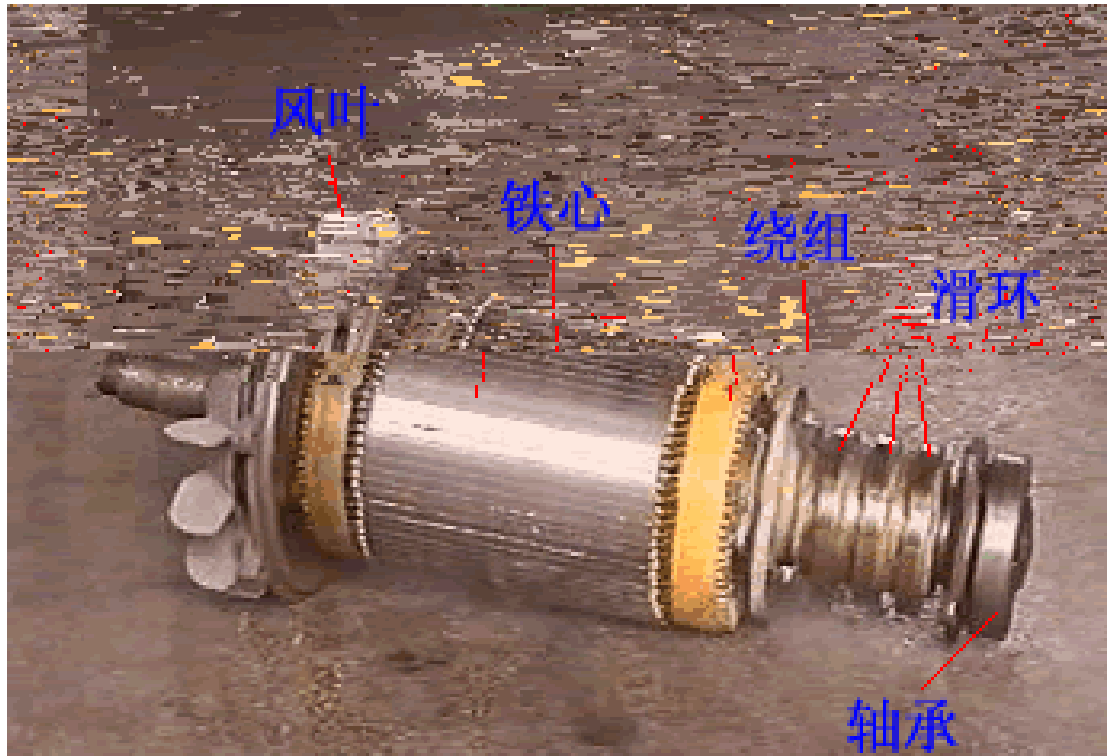

2011-11-1

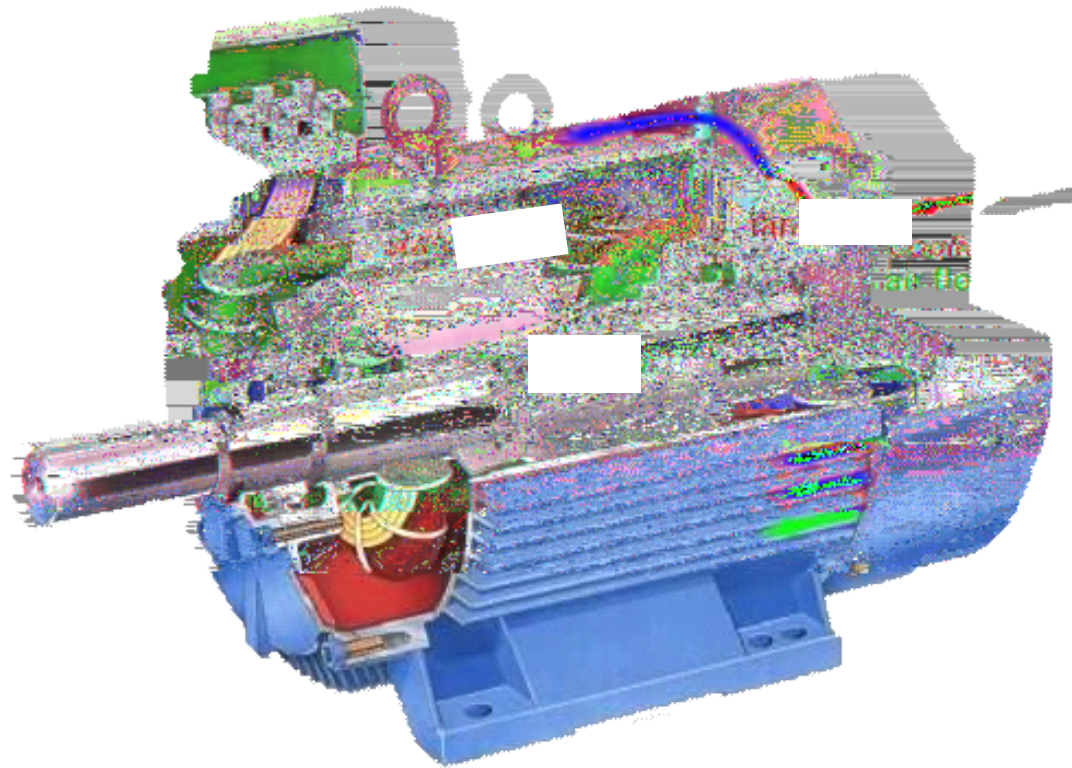

2011-11-1

2011-11-1



$$\left\{ \begin{array}{l} = I \quad \omega \\ = I \quad (\omega - \quad \circ) \\ = I \quad (\omega + \quad \circ) \end{array} \right.$$

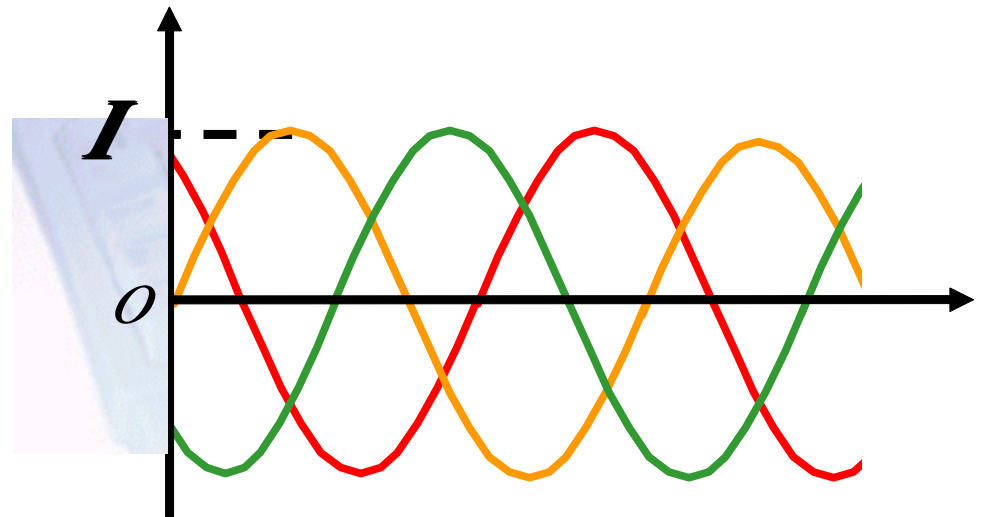
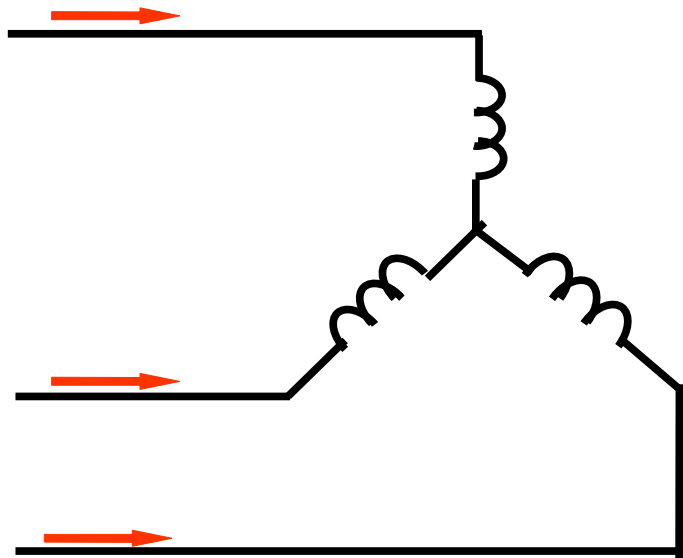

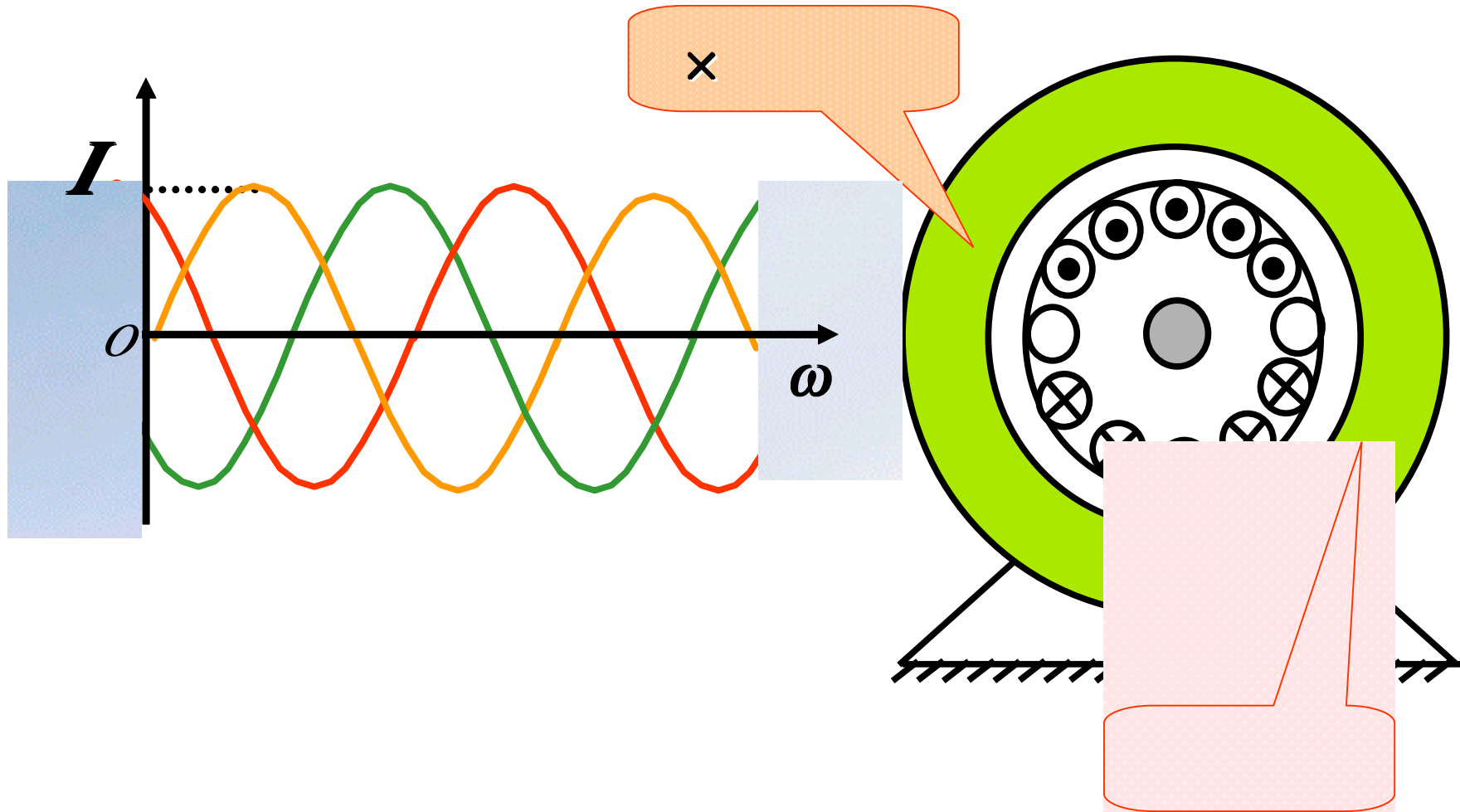

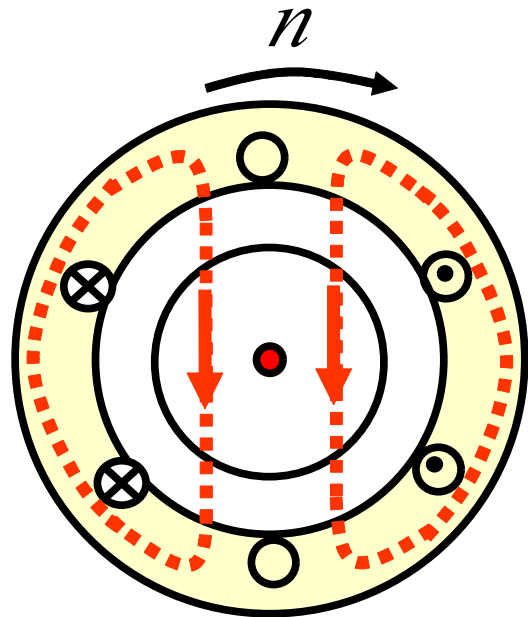
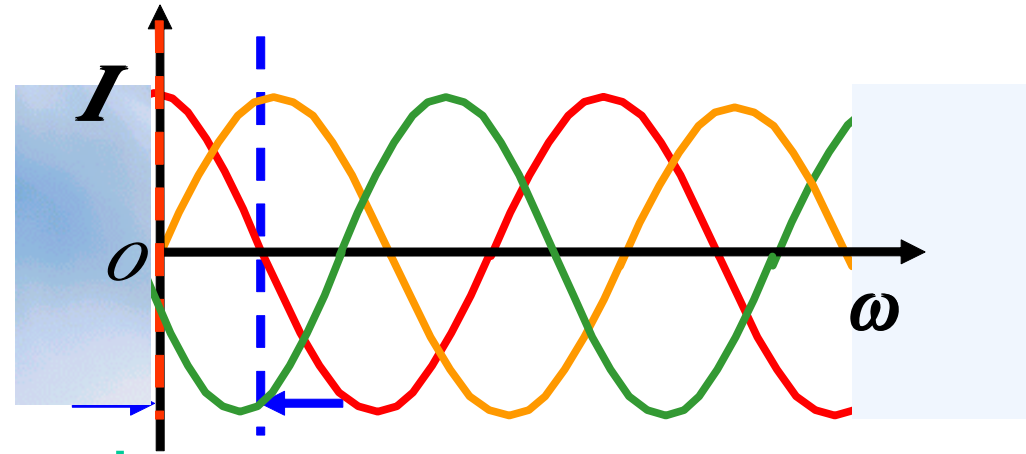

$$\omega =$$

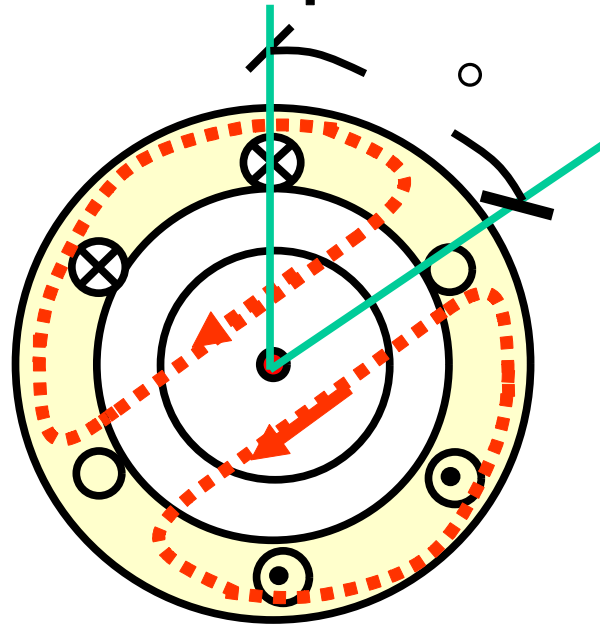

$$\omega = \circ$$

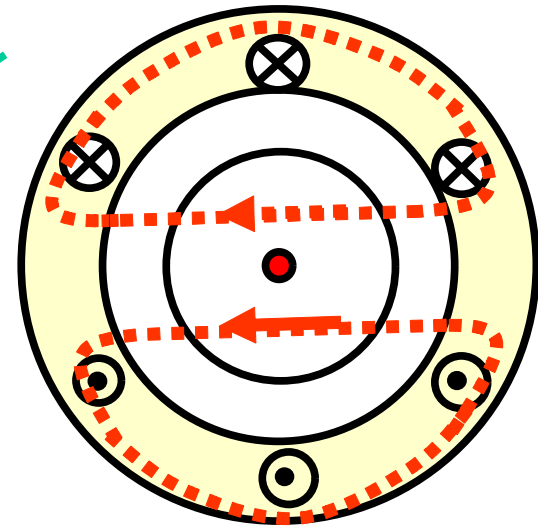

$$\omega = \circ$$

2011-11-1

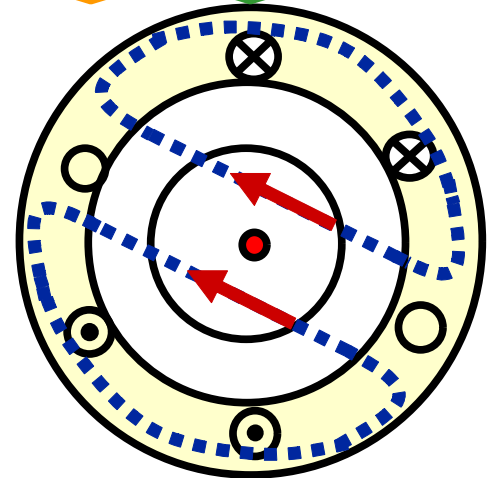
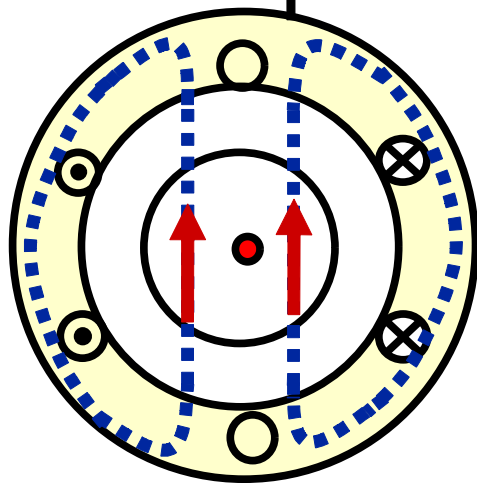
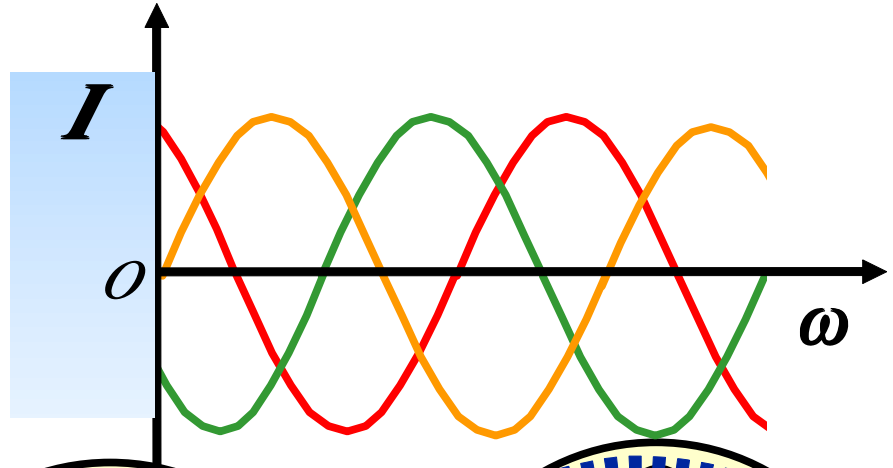
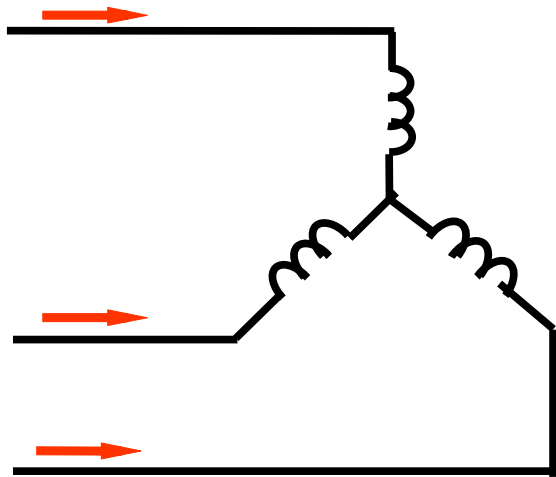

2011-11-1



$$\omega =$$

$$\omega = \text{ }^\circ 14$$



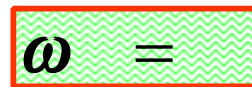
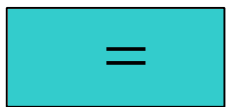
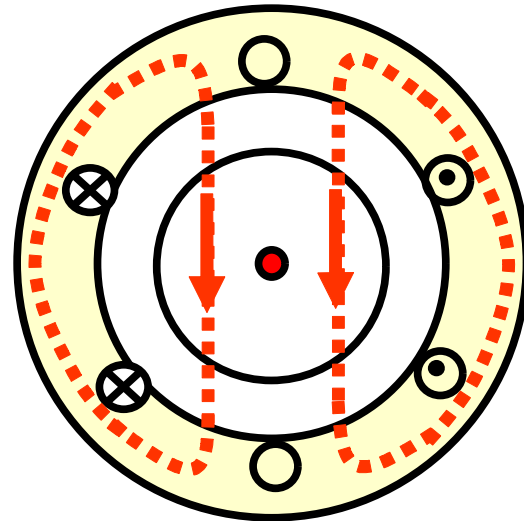
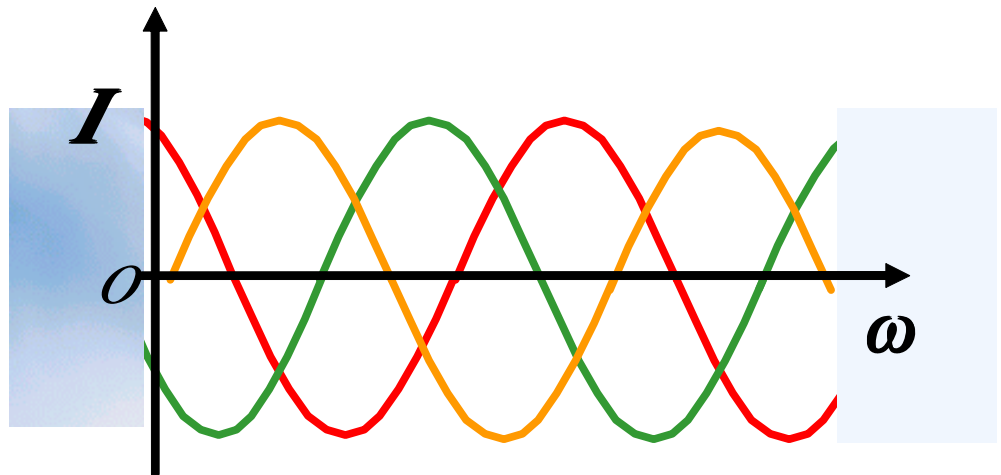
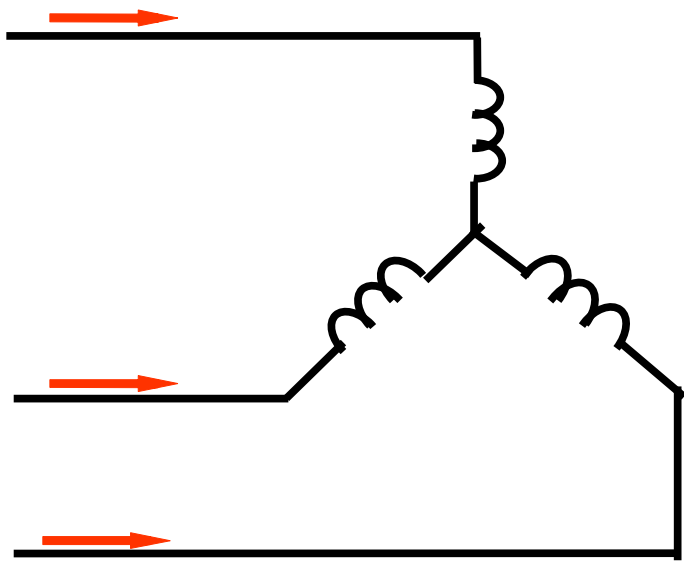

2011-11-1

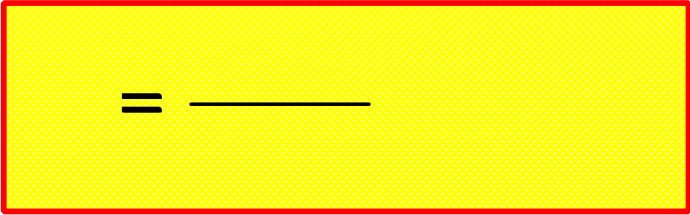

		=
$p =$	○	
$p =$	○	
$p =$	○	
=	○	

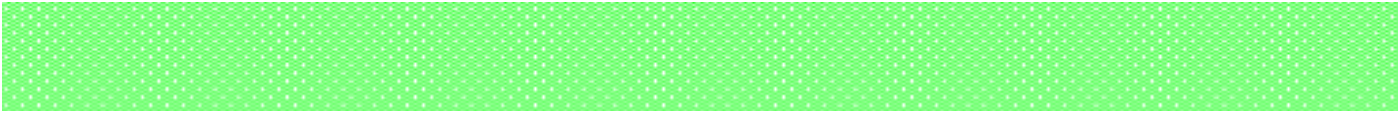

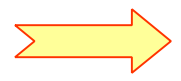
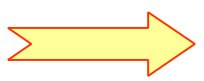
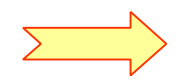
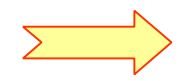

=

B

I

B

\rightarrow

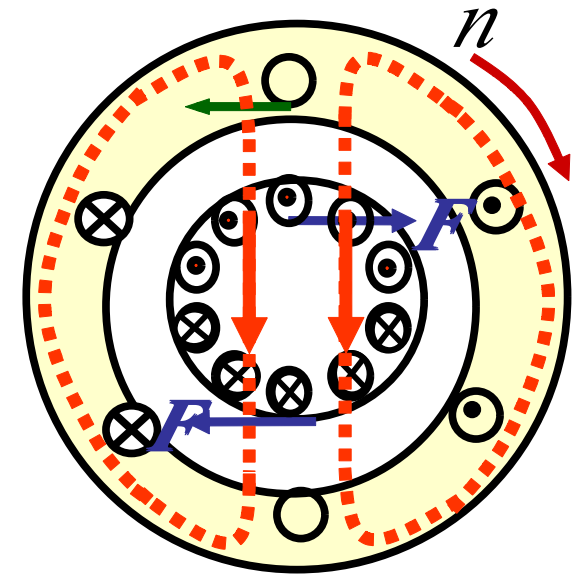

2011-11-1

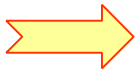

=

<

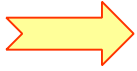
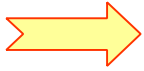
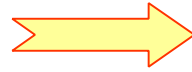

2011-11-1



22

$$= \left(\frac{-}{-} \right) \times$$

$$= -$$

$$s =$$

$$= \frac{-}{-} \times$$

$$= \frac{-}{-} \times$$

=

2011-11-1

23



$$\begin{array}{ccc}
 & \Phi & \rightarrow \\
 \approx E & & N \Phi \\
 E & & N \Phi \\
 E & E &
 \end{array}$$

$$\Phi_m \approx \frac{U}{f N}$$

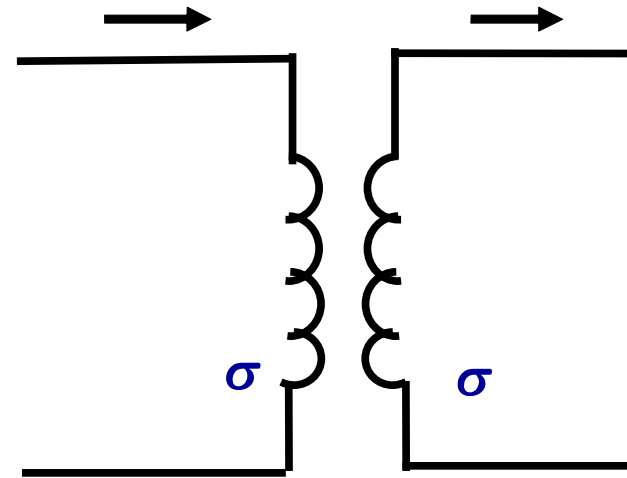

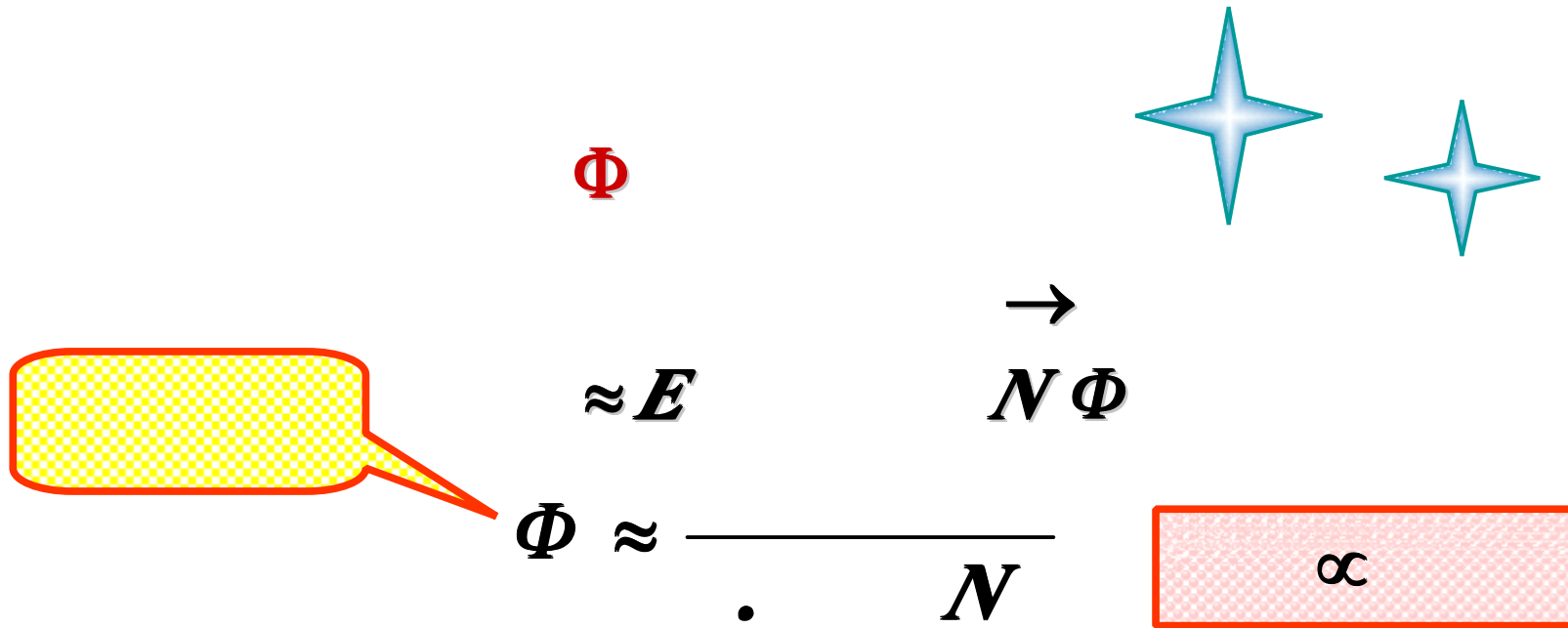

$$f = \frac{pn}{\cdot}$$



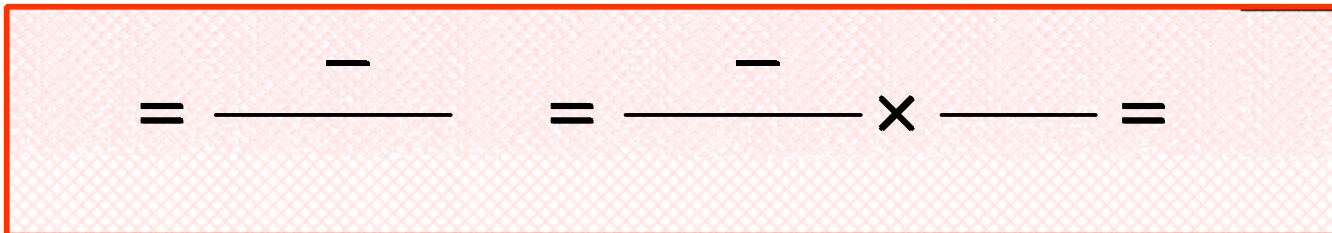
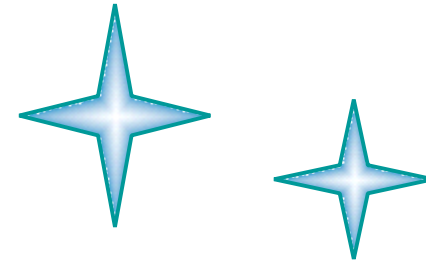

E $N\Phi$ E

$N\Phi$ E E

E $N\Phi$

E E

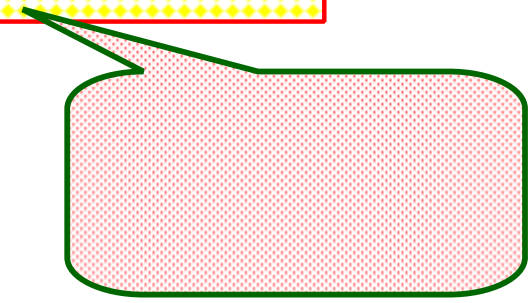
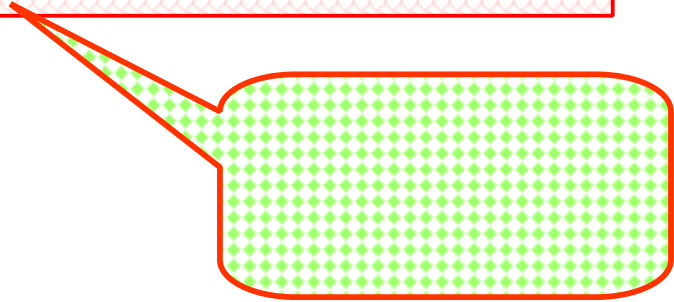

$$= \pi L = \pi L$$

πL_σ



$$\begin{aligned}
 I &= \frac{I E}{\sqrt{+ E}} \\
 &= \frac{E}{\sqrt{+}}
 \end{aligned}
 \left\{
 \begin{aligned}
 &= \rightarrow I = \\
 &= \rightarrow I = \frac{E}{\sqrt{+}}
 \end{aligned}
 \right.$$

$$\begin{aligned}
 \psi &= \frac{\psi}{\sqrt{+}} \\
 &= \frac{\psi}{\sqrt{+}}
 \end{aligned}
 \left\{
 \begin{aligned}
 &\gg \\
 &\psi \approx \\
 &\ll \\
 &\psi \propto -
 \end{aligned}
 \right.$$

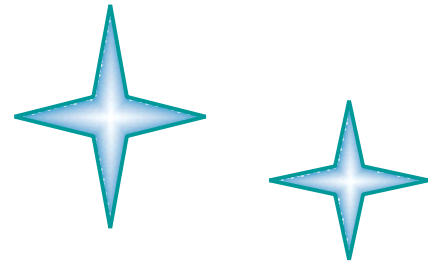

$I \quad \psi \quad s$

$$I = \frac{E}{\sqrt{\quad + \quad}} = \frac{E}{\sqrt{\quad + \quad}}$$

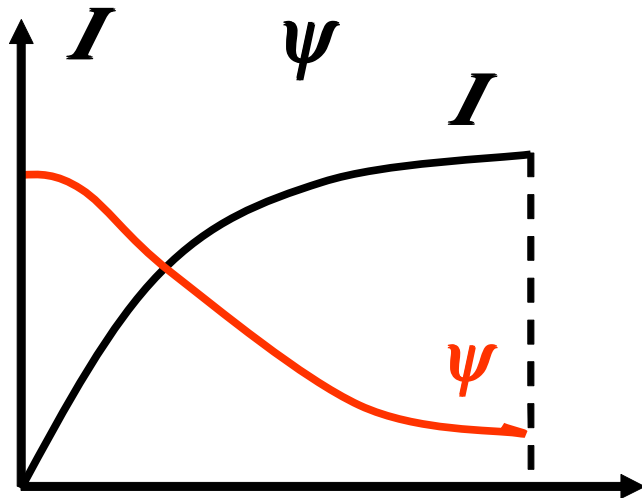
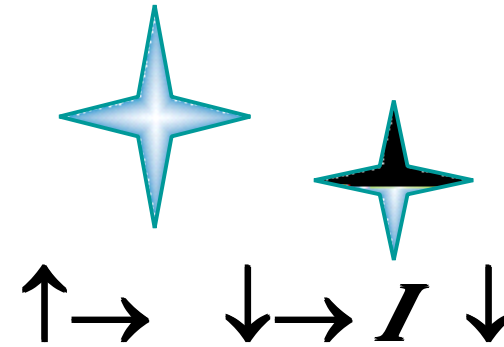

$$\psi = \frac{\quad}{\sqrt{\quad + \quad}}$$

$\uparrow \rightarrow \quad \downarrow \rightarrow \quad \psi \quad \uparrow$

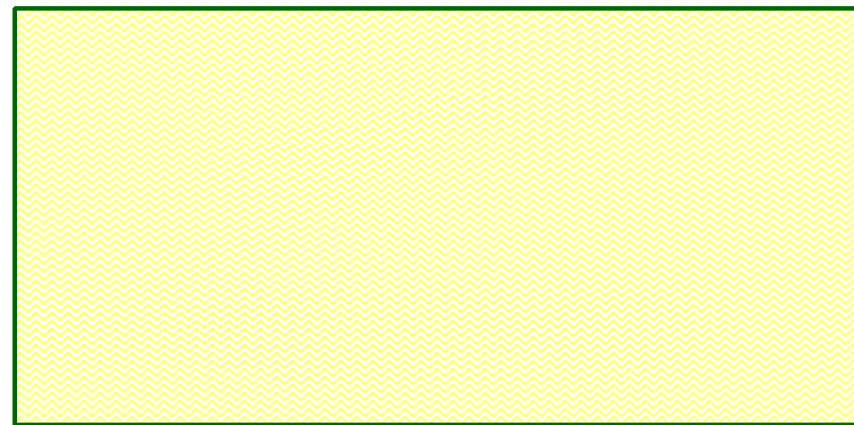

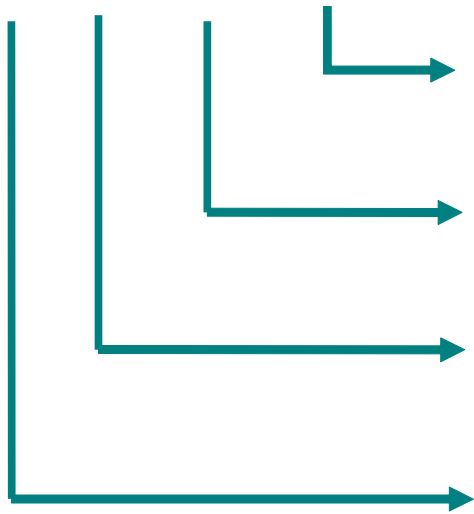

2011-11-1

2011-11-1



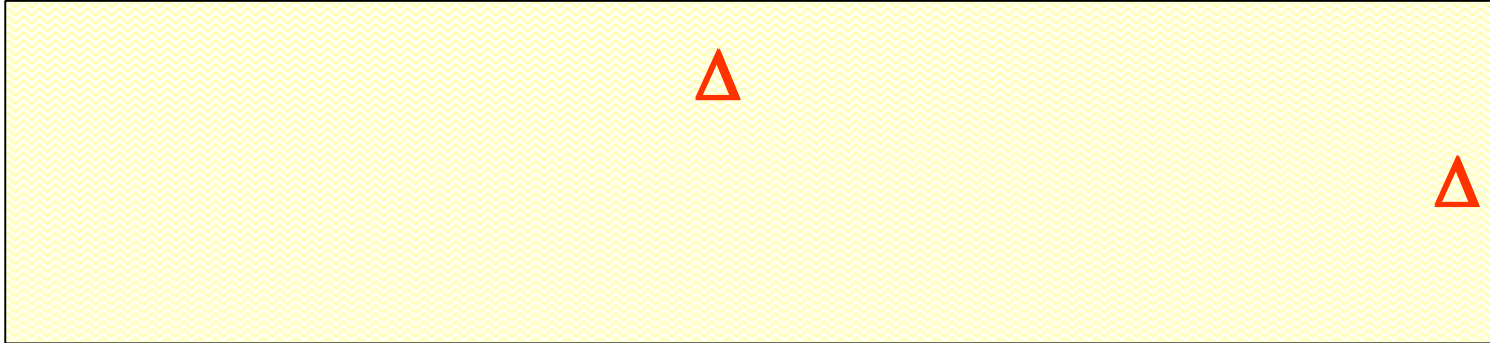

2011-11-1

32





2011-11-1

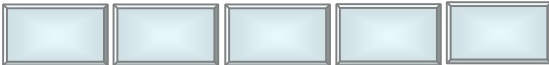

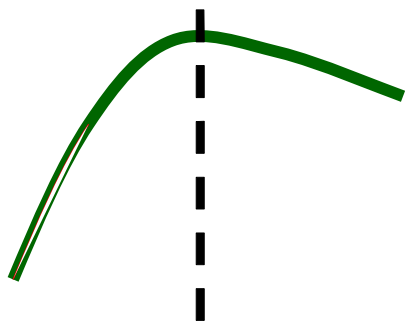

2011-11-1

—
=

2011-11-1

35



$$F = B$$

$$\propto I \psi$$

$$= K I \psi$$

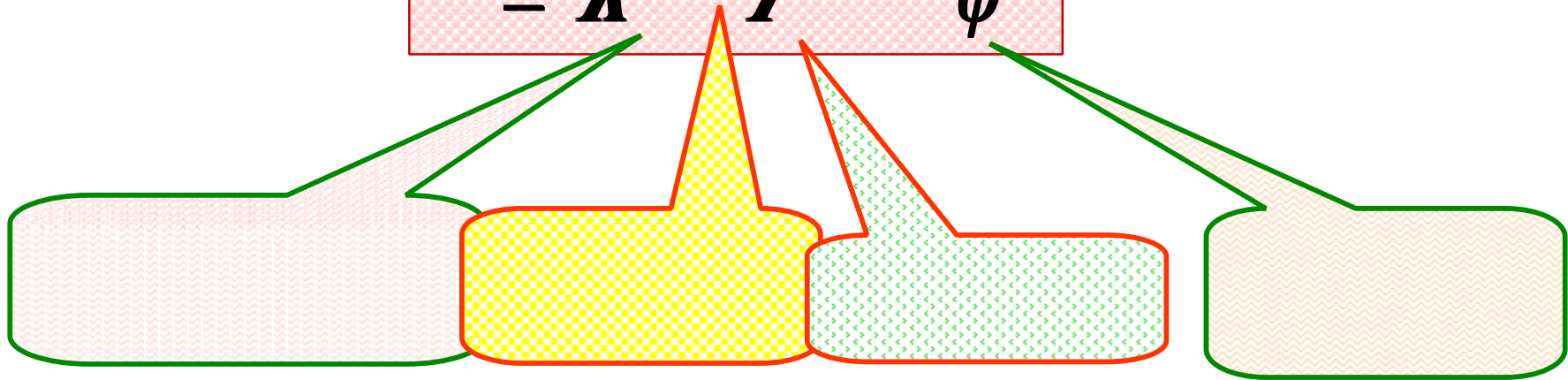

$$= K I \psi$$

$$\left\{ \begin{array}{l} I = \frac{E}{\sqrt{\quad + \quad}} \\ \psi = \frac{\quad}{\sqrt{\quad + \quad}} \\ U = f N \end{array} \right.$$

$$= K \frac{\quad}{\quad + \quad} \cdot$$

$$= K \frac{\quad}{\quad} \cdot$$

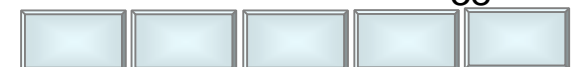
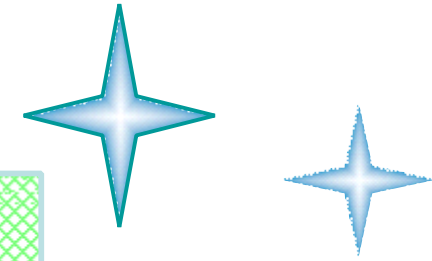

$$= K \frac{\quad}{\quad + \quad}$$

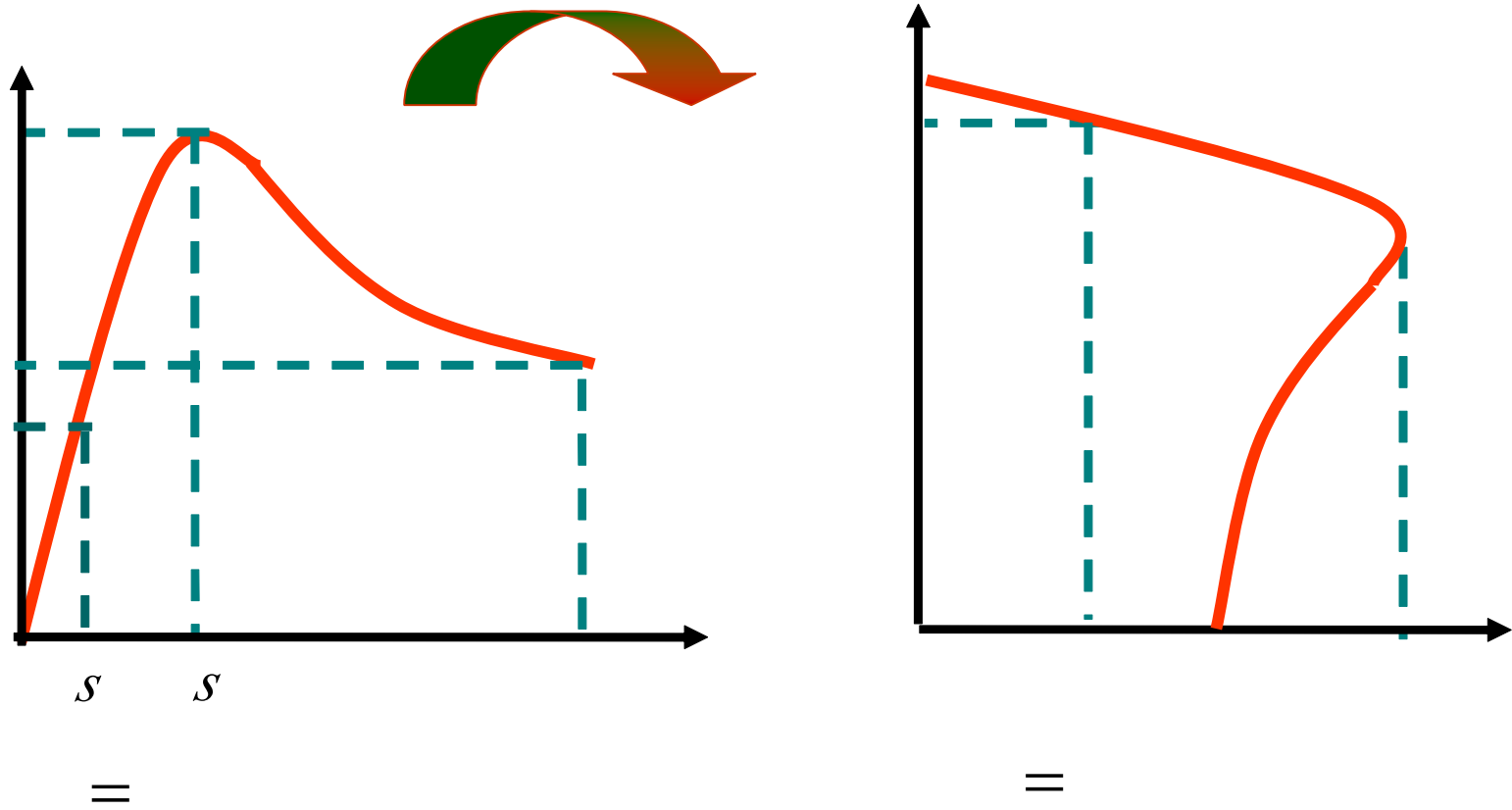

2011-11-1



$$= \frac{\quad}{\quad} = \quad$$

$$= \frac{\quad}{\quad}$$

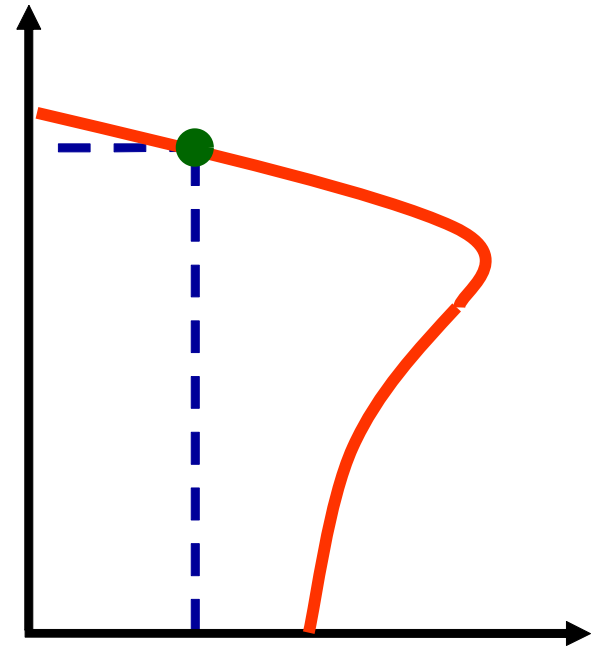

$$= \frac{\quad}{\quad} = \frac{\quad}{\quad}$$

2011-11-1



$$= K \frac{\dots}{\dots} + \dots = \dots$$

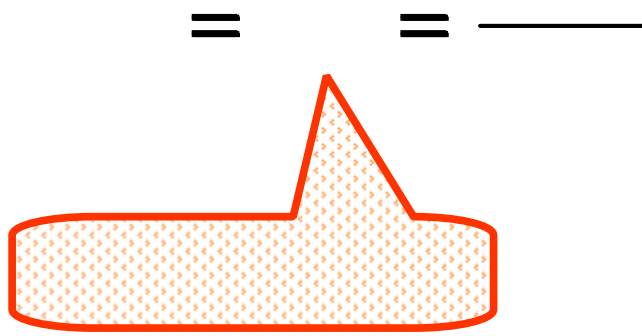
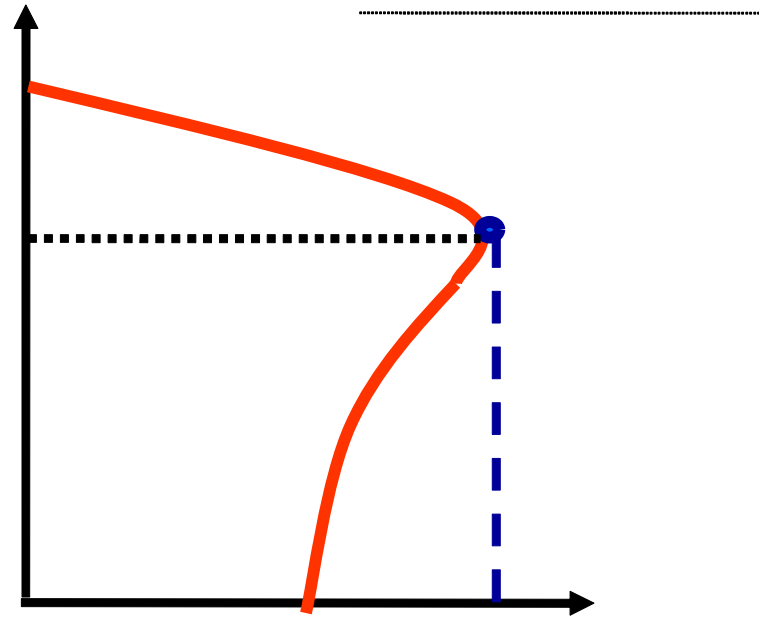

$$= K \frac{\dots}{\dots}$$

$$\infty \quad = \mathbf{K} \text{ —————}$$

$\downarrow \rightarrow$ $\downarrow \downarrow$

$\uparrow \rightarrow$ $\uparrow \rightarrow$

$\lambda = \text{—————} \downarrow$

$$\lambda =$$

$$\Rightarrow \mathbf{I} \uparrow \Rightarrow \mathbf{I} \uparrow \Rightarrow$$

2011-11-1

$$= \mathbf{K} \frac{\quad}{+}$$

$$= \mathbf{K} \frac{\quad}{+}$$

$$\propto \begin{array}{c} \downarrow \rightarrow \quad \downarrow \downarrow \end{array}$$

$$\begin{array}{c} \uparrow \rightarrow \quad \uparrow \end{array}$$

,

$$\mathbf{K} = \frac{\quad}{\quad}$$

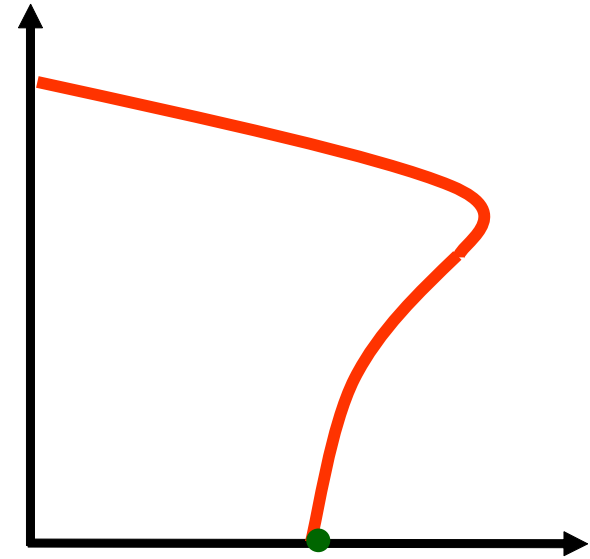

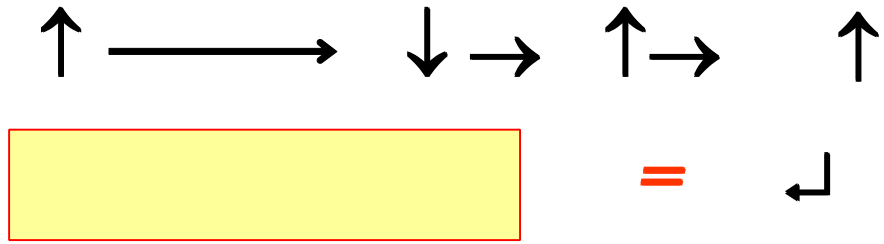

\downarrow $\uparrow \rightarrow E$ $I \uparrow \rightarrow I \uparrow$

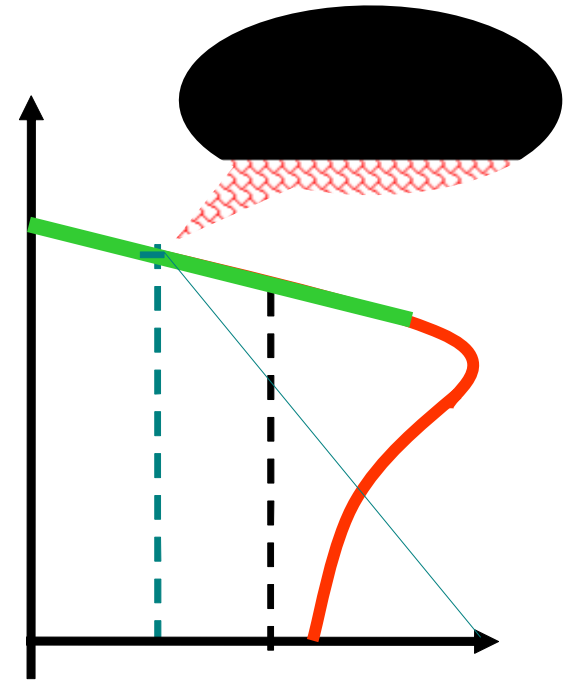

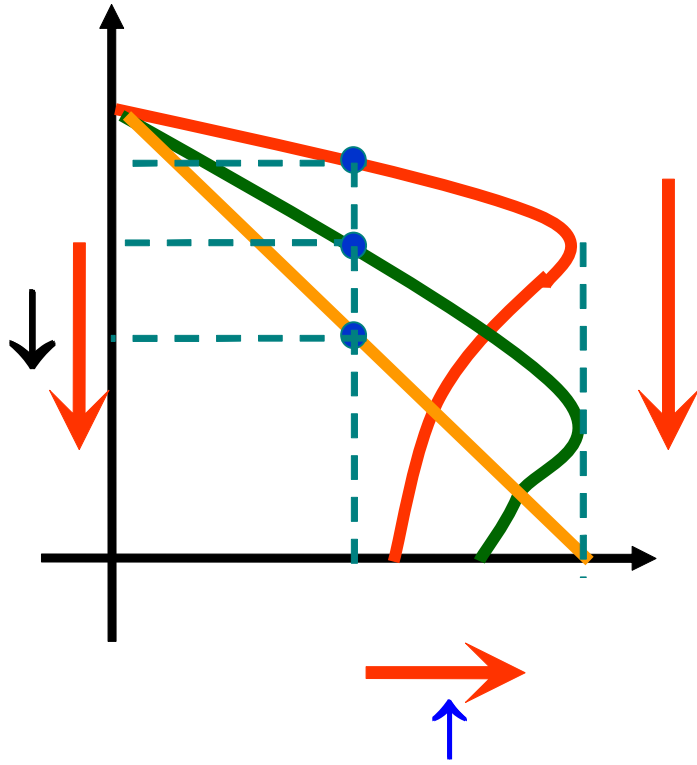

$$= \text{_____}$$

$$= K \text{_____}$$

$$= K \frac{\text{_____}}{\text{_____} + \text{_____}}$$



=

=

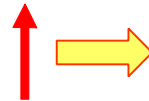
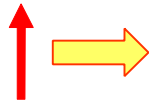

{

2011-11-1

47





}

Δ

2011-11-1

48



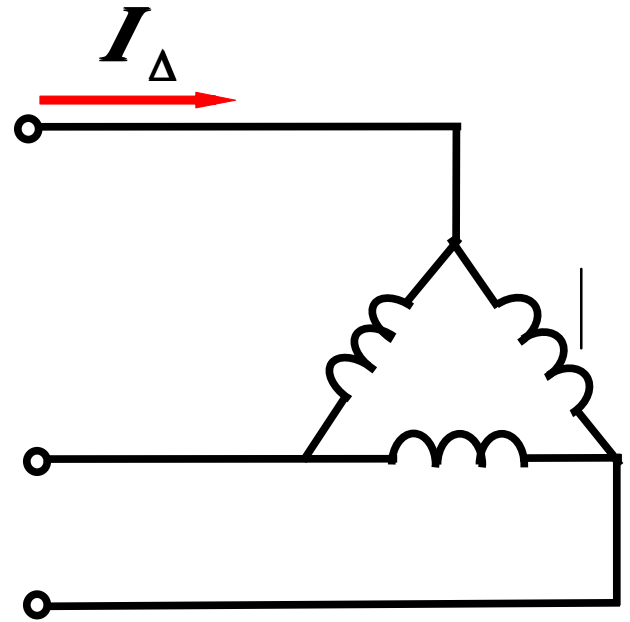
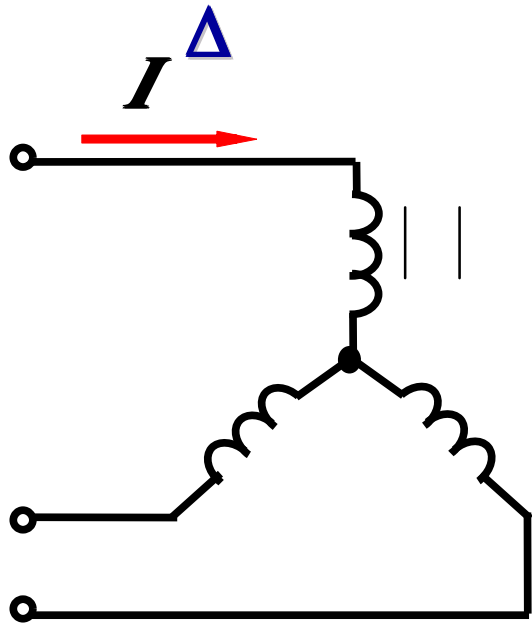

$$I_{\Delta} = \sqrt{\frac{|Z|}{3}}$$

$$I = \frac{I_{\Delta}}{\sqrt{3}}$$

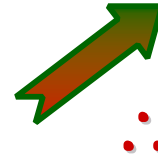

$$\frac{I}{I_{\Delta}} = \frac{1}{\sqrt{3}}$$



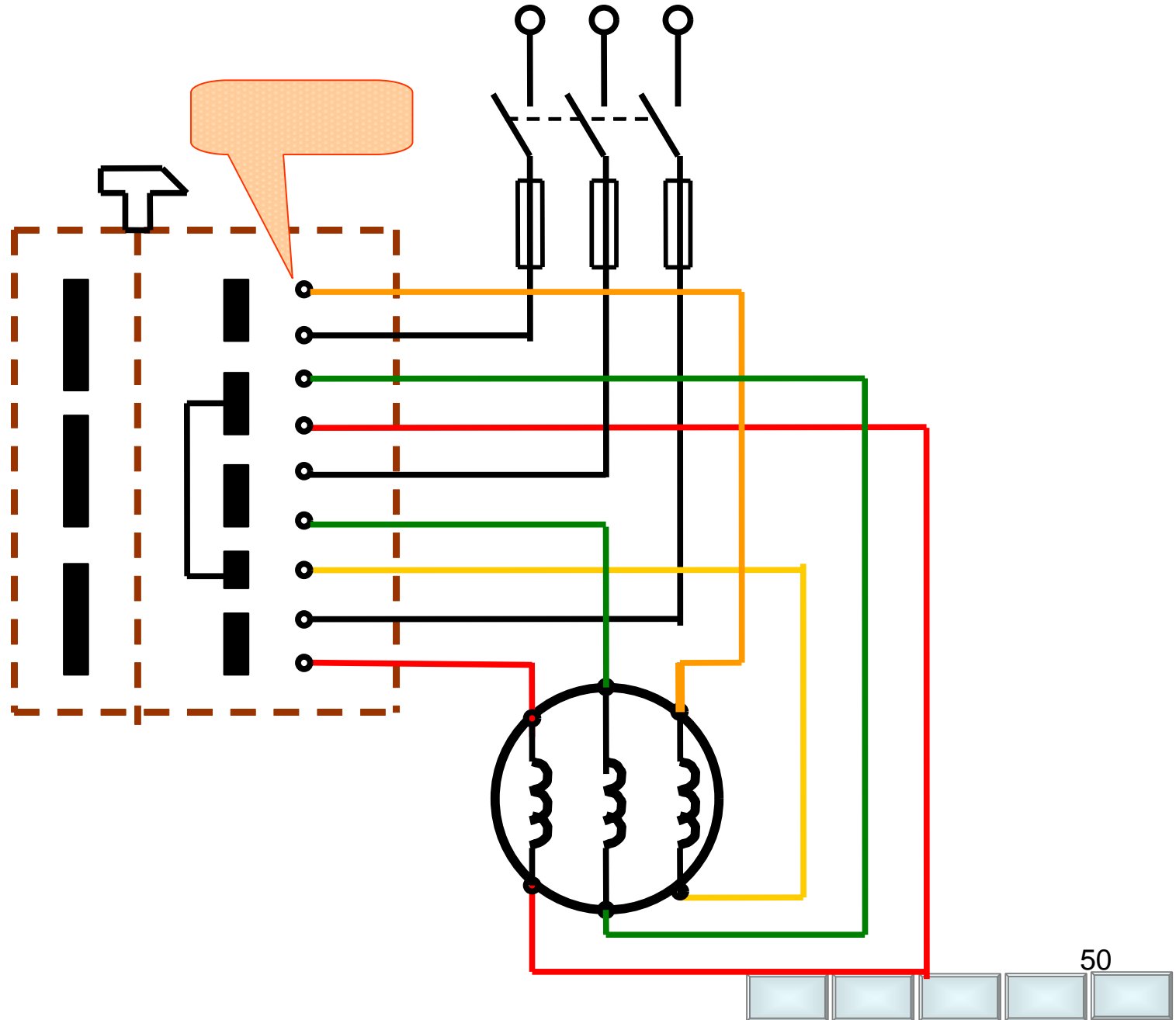

2011-11-1

50

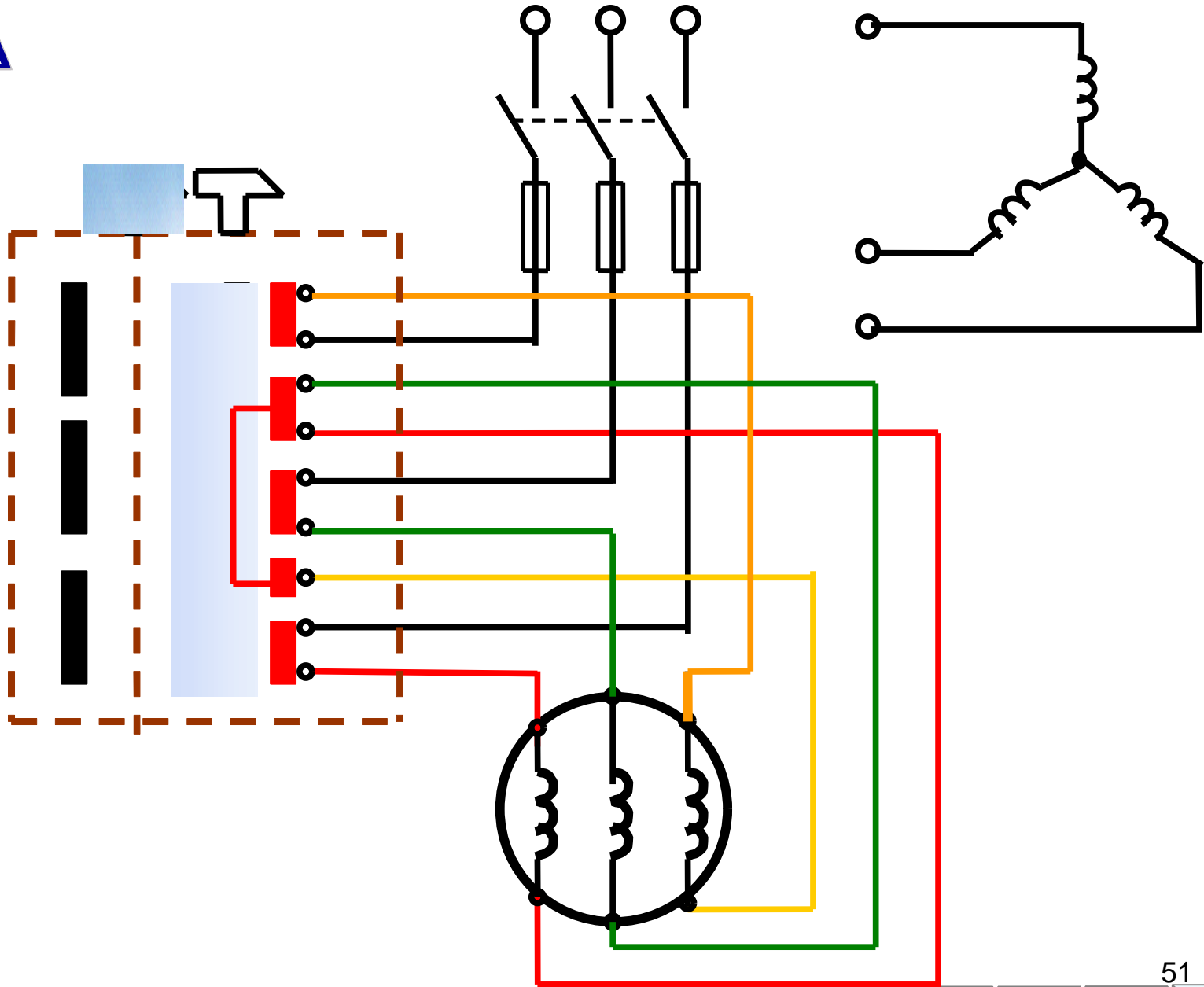

2011-11-1

51



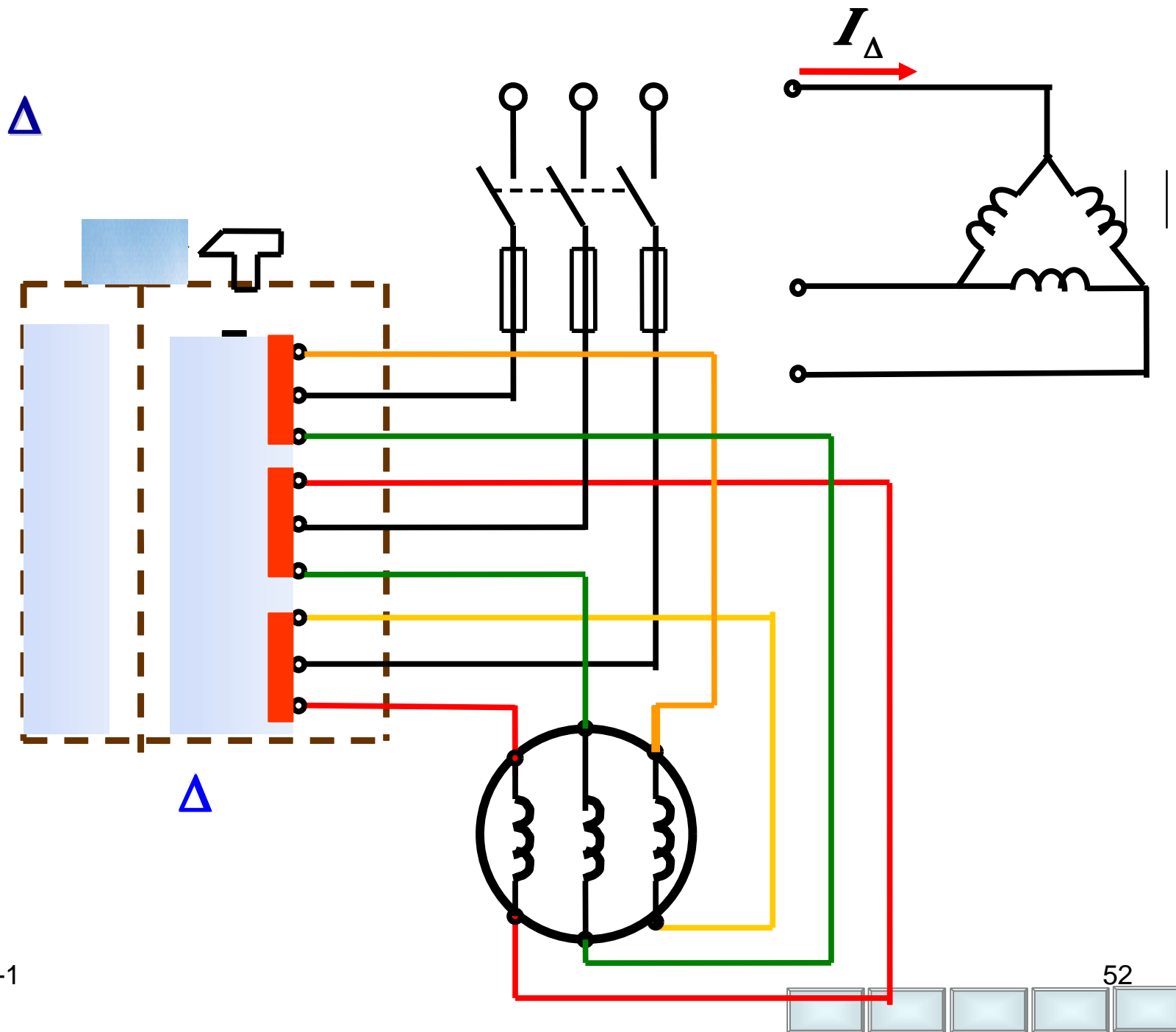

2011-11-1

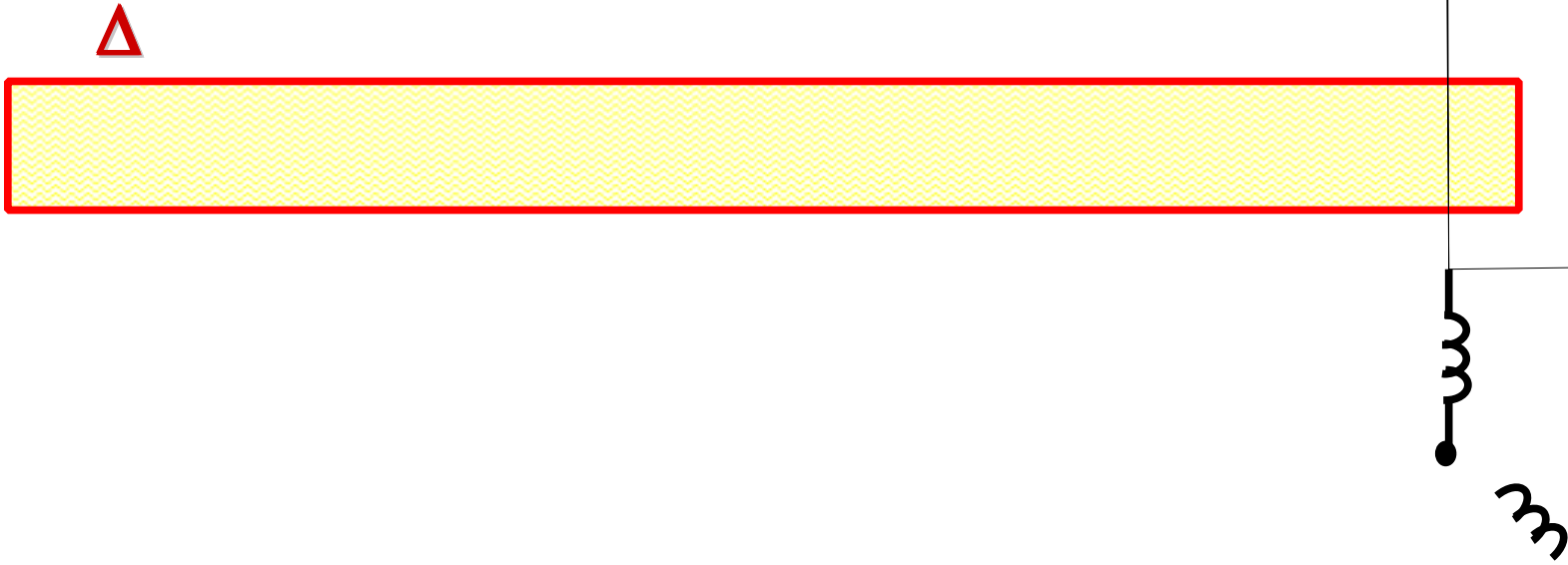

$$\Delta \quad I \quad \downarrow \rightarrow \quad \downarrow \quad \propto$$

$$= \frac{\quad}{\sqrt{\quad}} \quad \rightarrow \quad = \quad -$$



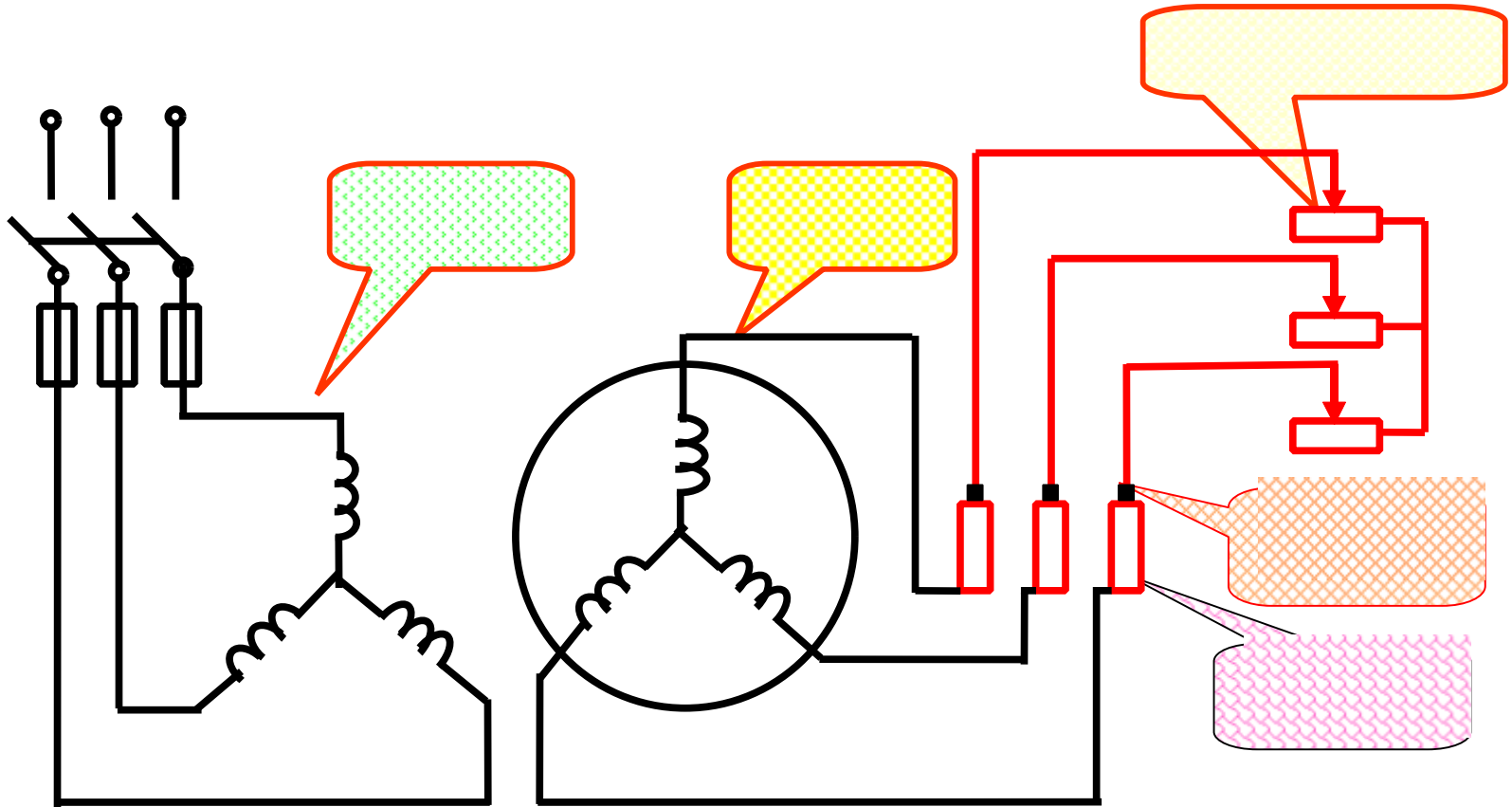

$$I = \frac{E}{\sqrt{3} + \dots} \Rightarrow ' \uparrow \Rightarrow I \downarrow \Rightarrow I \downarrow$$

2011-11-1



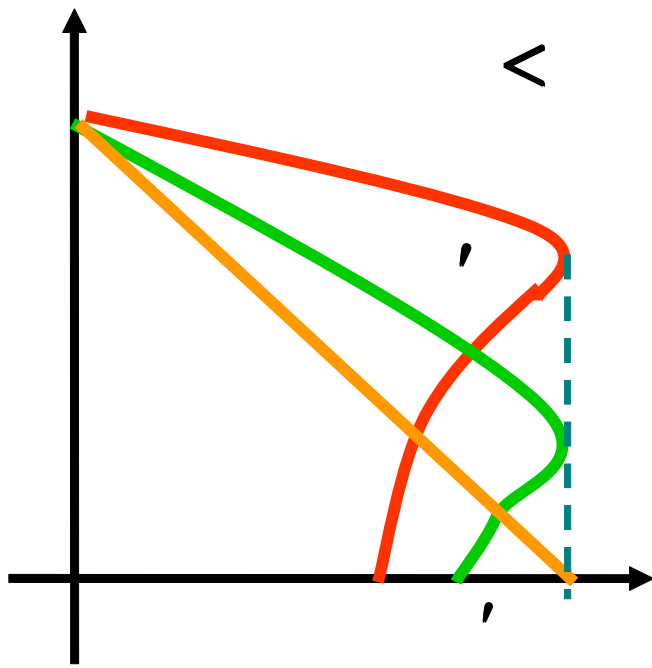

$$= K \frac{\quad}{\quad + \quad}$$

$\uparrow \Rightarrow \quad \uparrow$

2011-11-1



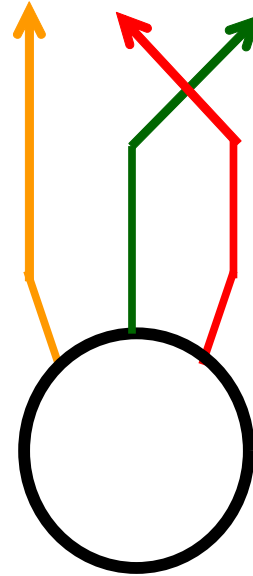
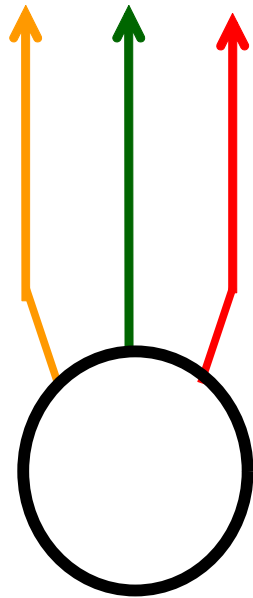

2011-11-1

$\sqrt{\quad}$

2011-11-1

△

= . × . = . < . .

2011-11-1

$$I \triangle I \times$$

$$I = -I = -\times \quad \cdot = \quad \cdot$$

$$= - \quad = -\times \quad \cdot = \quad \cdot \quad \cdot$$

$$\frac{\quad}{\times} = \frac{\quad \cdot}{\cdot \times} = \frac{\cdot}{\cdot} <$$

$$\frac{\quad}{\times} = \frac{\quad \cdot}{\cdot \times} = \frac{\cdot}{\cdot} >$$



$$\frac{I''}{I'} = \frac{\quad}{\quad} =$$

$$I'' = \cdot \quad I' = \cdot \quad \times \quad \cdot \quad I = \cdot \quad I$$

$$= \quad \times \quad \cdot = \quad \cdot$$

$$\propto \quad \text{---} \quad \text{---} = \cdot$$



I''

$$I'' = I$$

'

$$' =$$

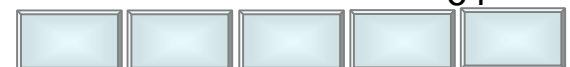

= (-) = (-) →

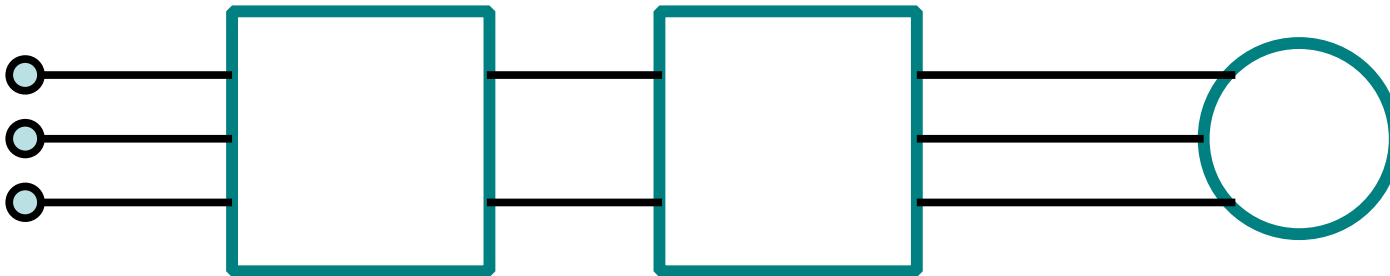

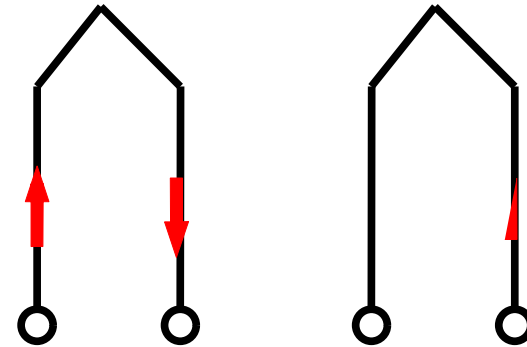

2011-11-1

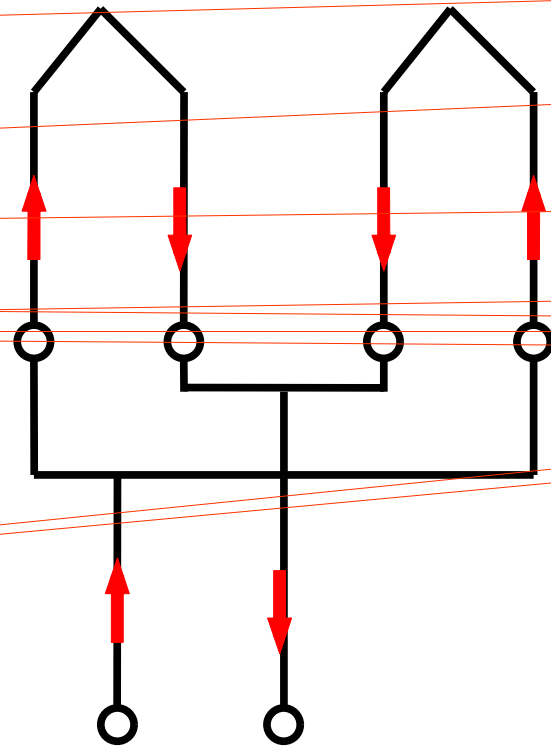
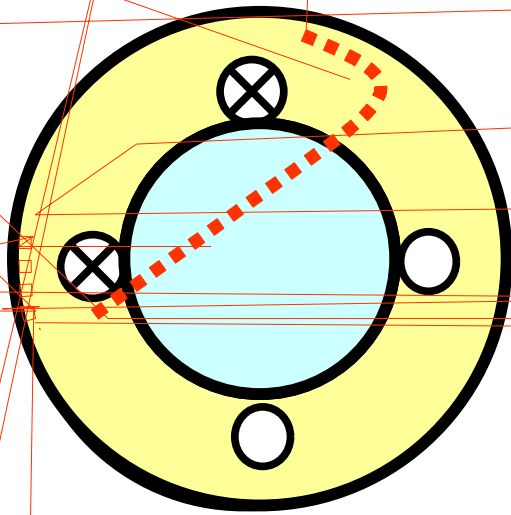

2011-11-1



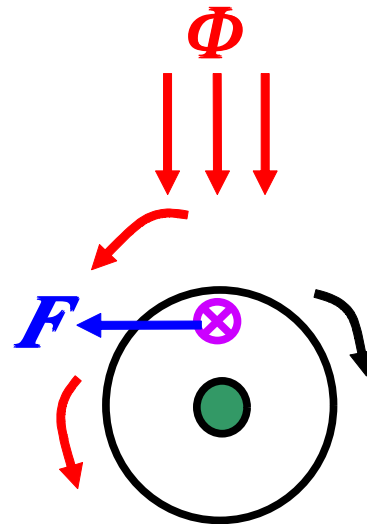
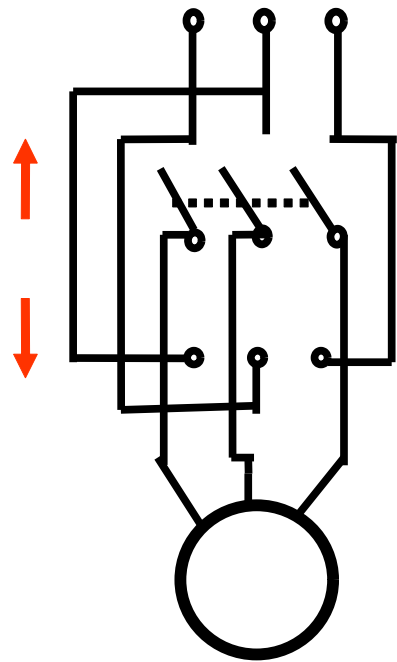

2011-11-1



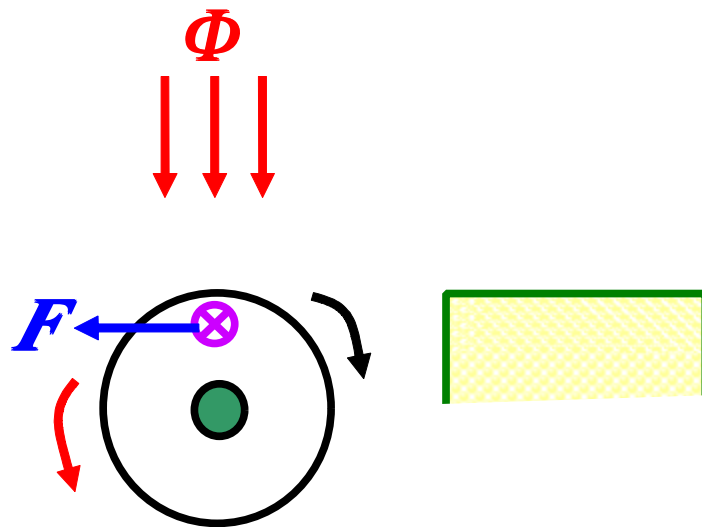

2011-11-1

71



2011-11-1

