

•

•

•

(/)
KCL KVL
VCR

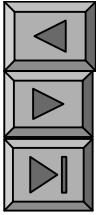

3 1



- KCL KVI
-



G

“(Graph)”

5

8

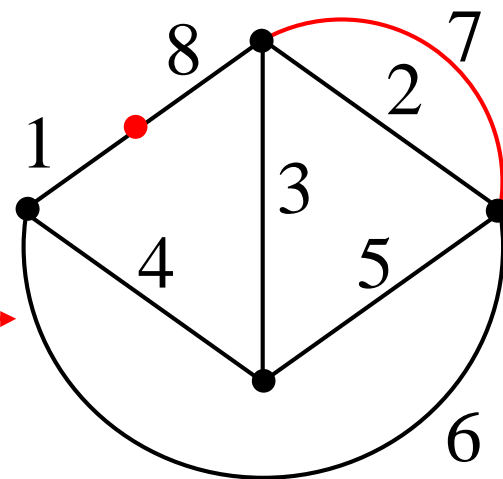
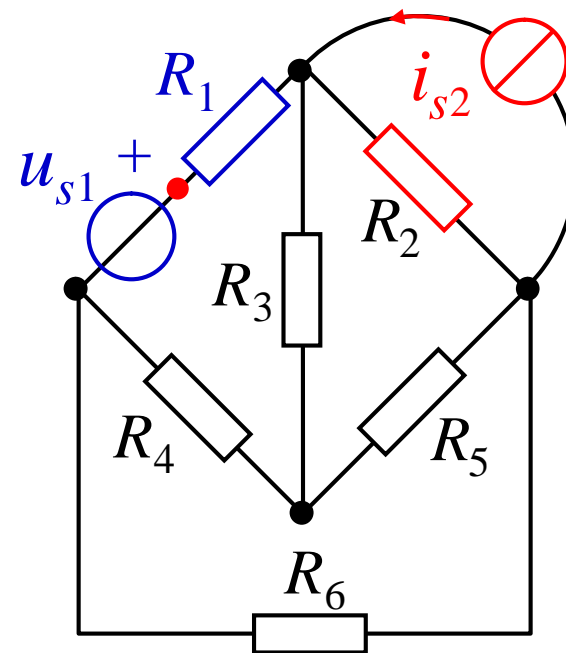

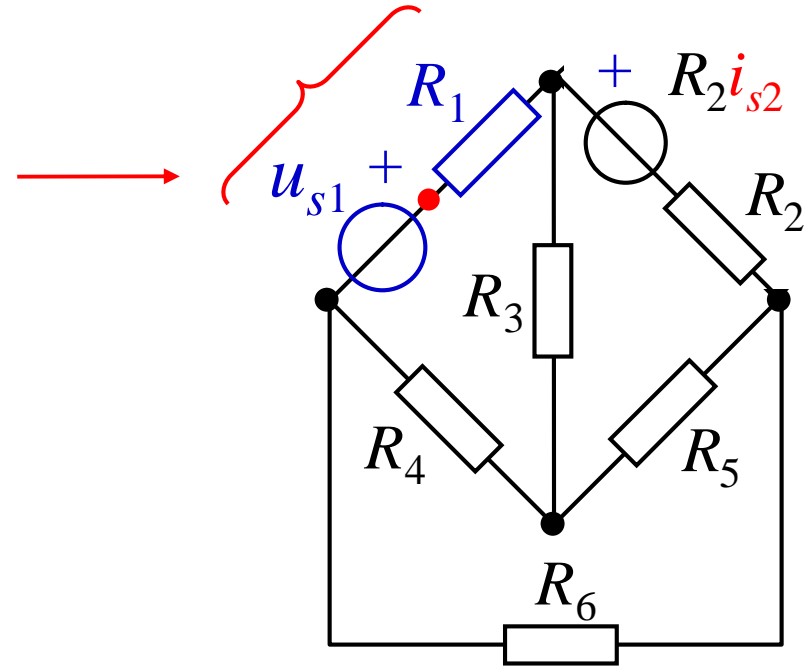
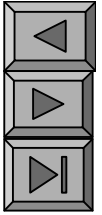

•

•

4

6

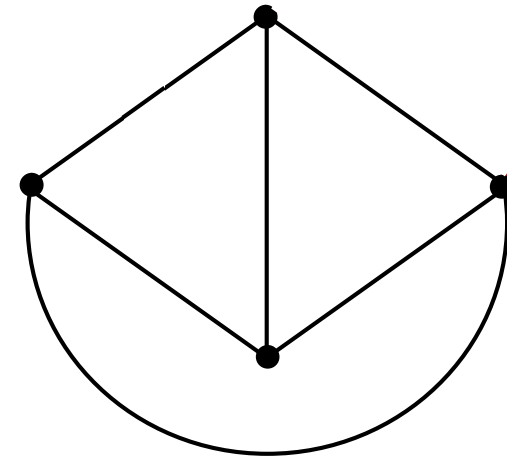

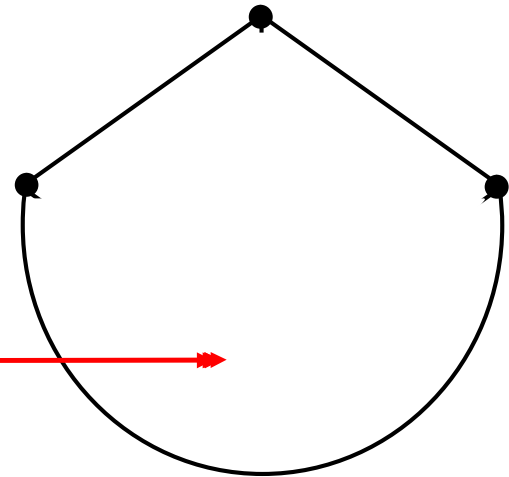
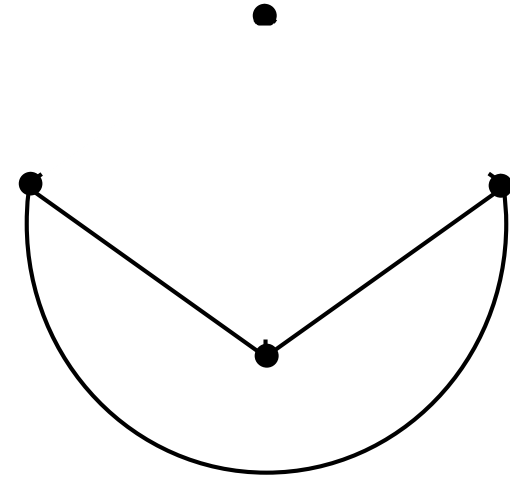
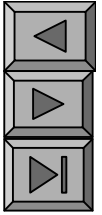

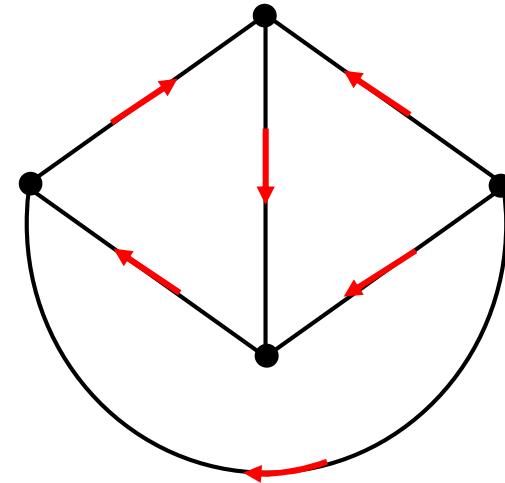
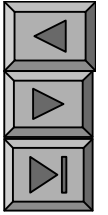

()



-
-
-

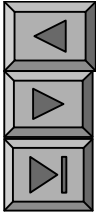

“ ”

3 2 KCL KVL

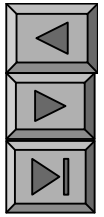

KCL

-

LVL

$$\begin{aligned}
 \cancel{i_1} + \underline{i_4} + \cancel{i_6} &= 0 \\
 \cancel{i_1} + \cancel{i_2} + \underline{i_3} &= 0 \\
 \cancel{i_2} + \underline{i_5} + \cancel{i_6} &= 0 \\
 \underline{i_3} + \underline{i_4} + i_5 &= 0
 \end{aligned}$$

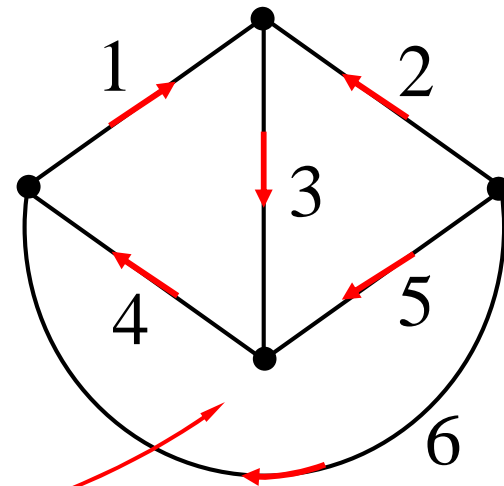

- 4

0

3

()

()

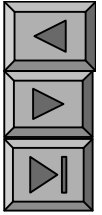

1.

()

G

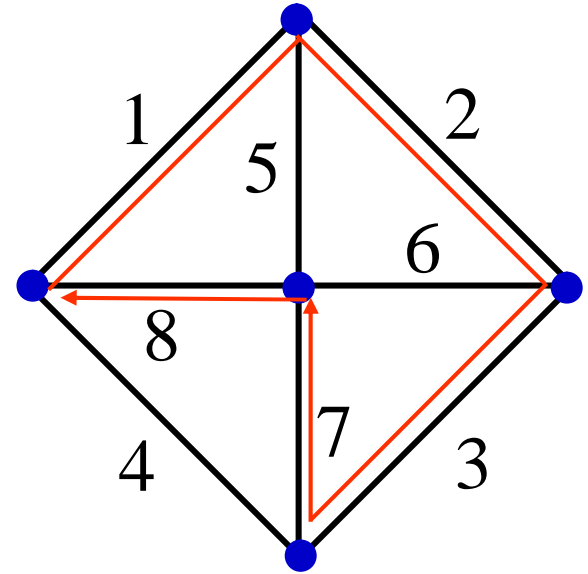

G

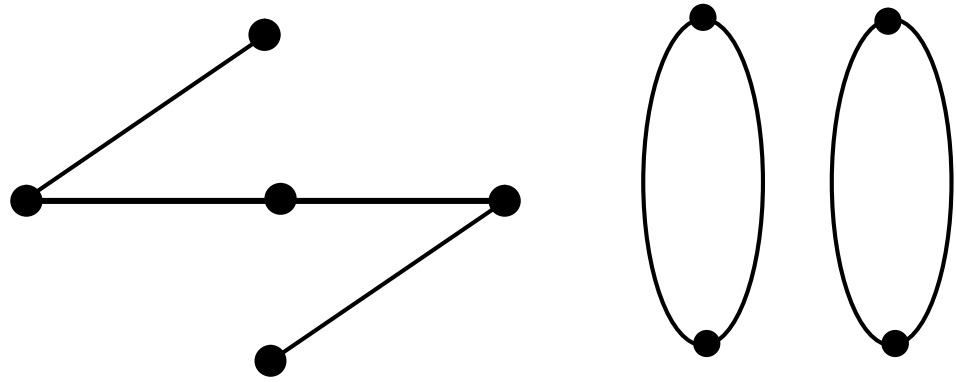

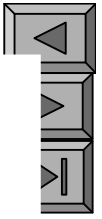

G
 (1,5,8) (2,5,6) (1,2,3,4)
 • 13
 13

1 5 2
 8 6
 4 7 3

2. (Tree)

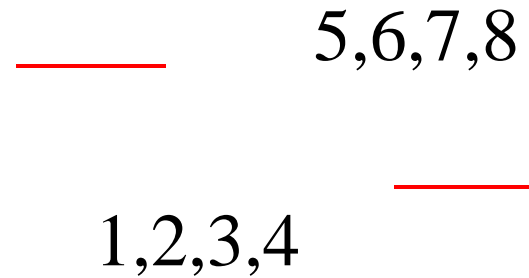
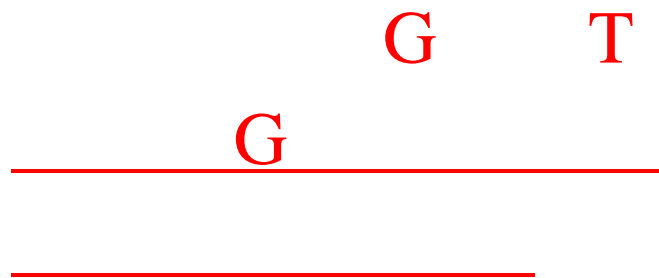

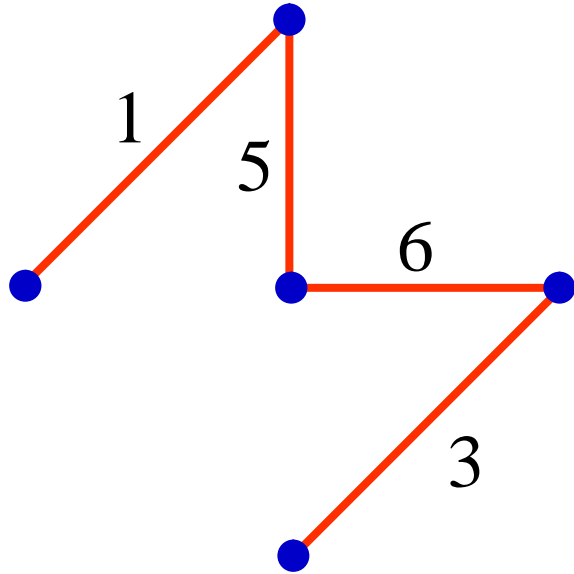
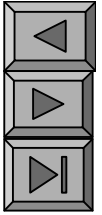

T

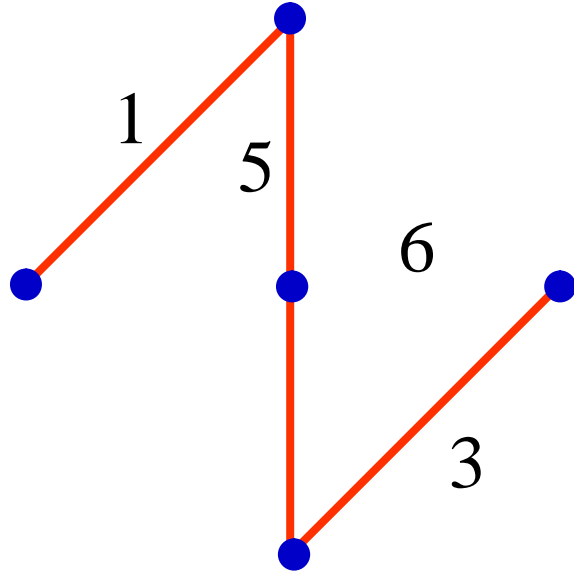
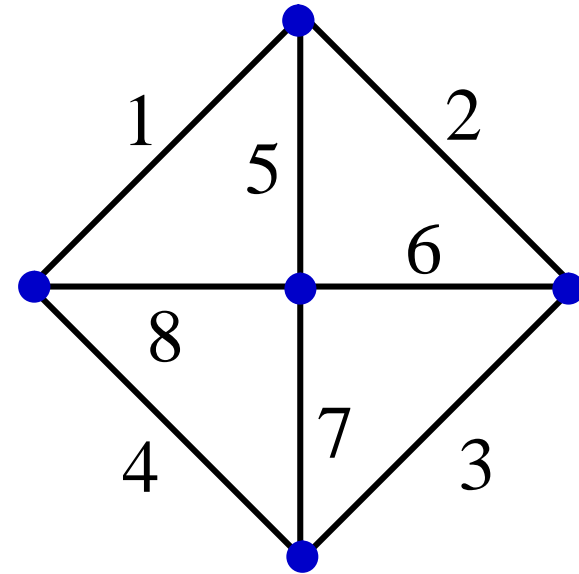

•

G 5
T

•

n
(n - 1)

4

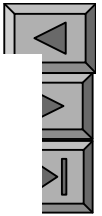

G
 $n (=5)$

-
-

1

G
2

(
)

$n (=5)$

$(n - 1 = 4)$

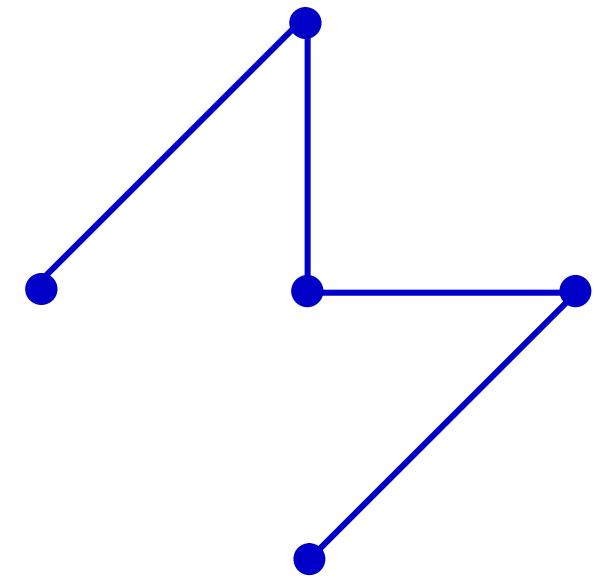

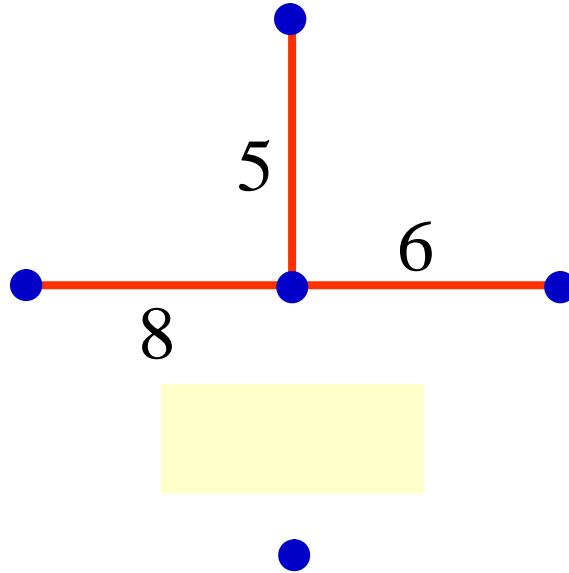
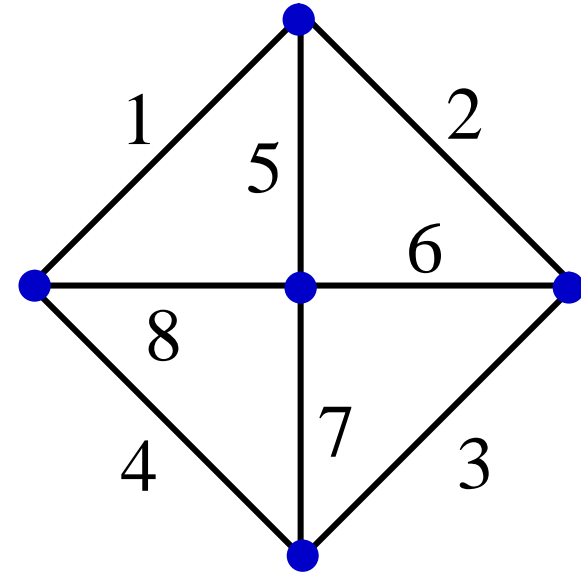
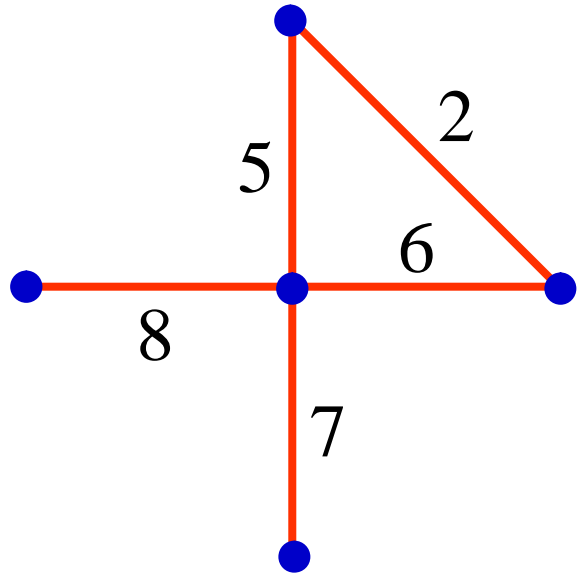
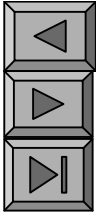

3.



)



(

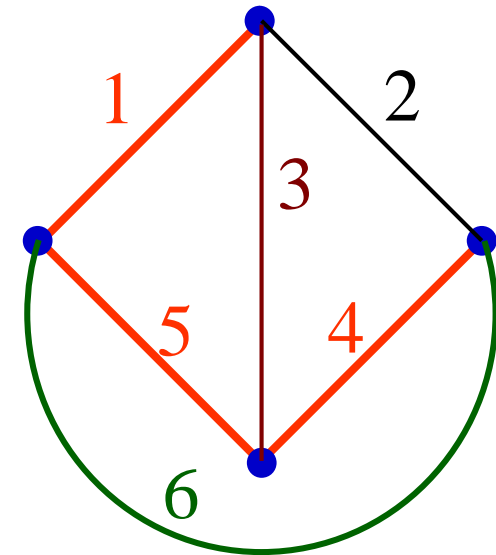
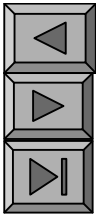
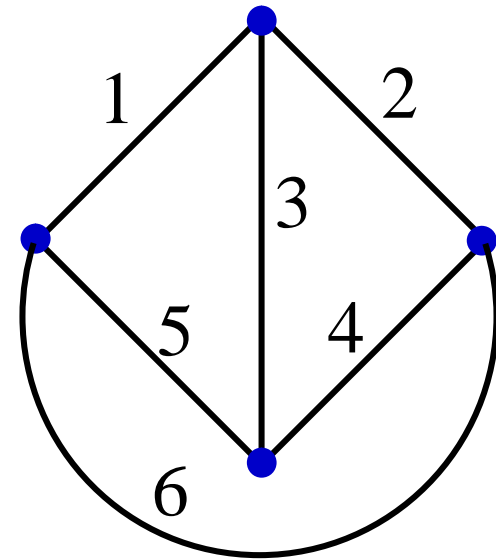

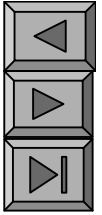

•



•

$G \quad n \quad b$
G $(n - 1)$

$b \quad (n - 1)$

•

$l = b \quad (n - 1)$

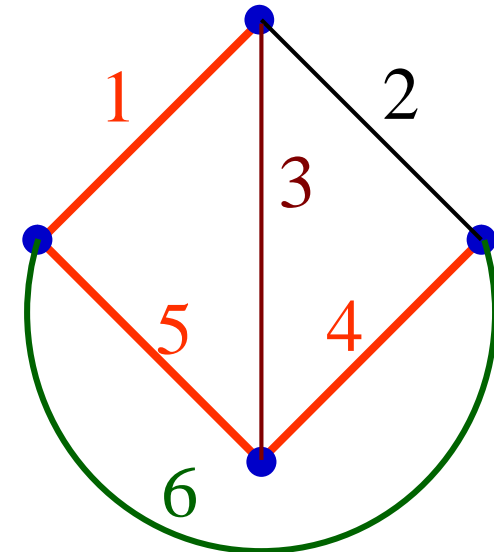
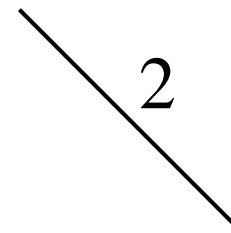

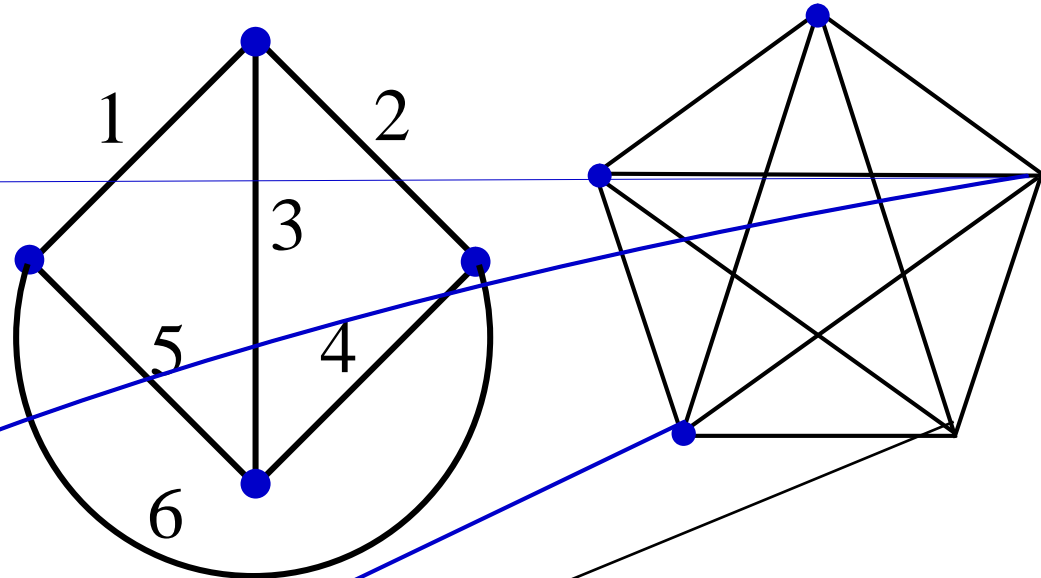
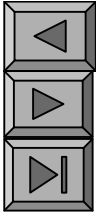

$l = b - (n - 1)$

 **KVL**

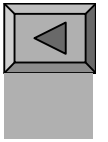

3 3

-
-

b :

KCL: $(n-1)$
 KVL: $(b-n+1)$

} b

VCR: b

n

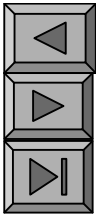
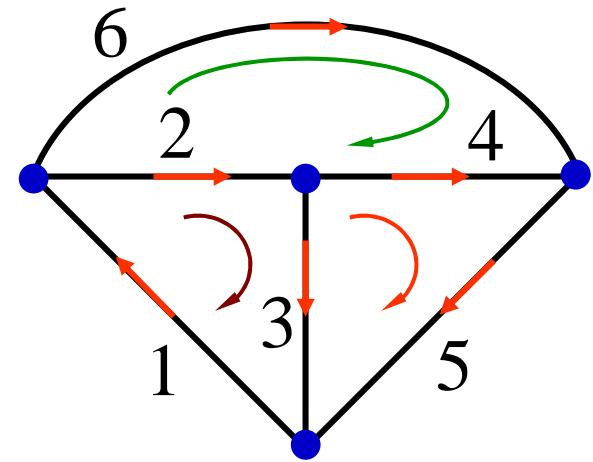

- $2b$
- $2b$ $2b$
- $2b$

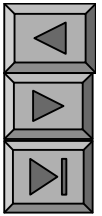

$2b$

b

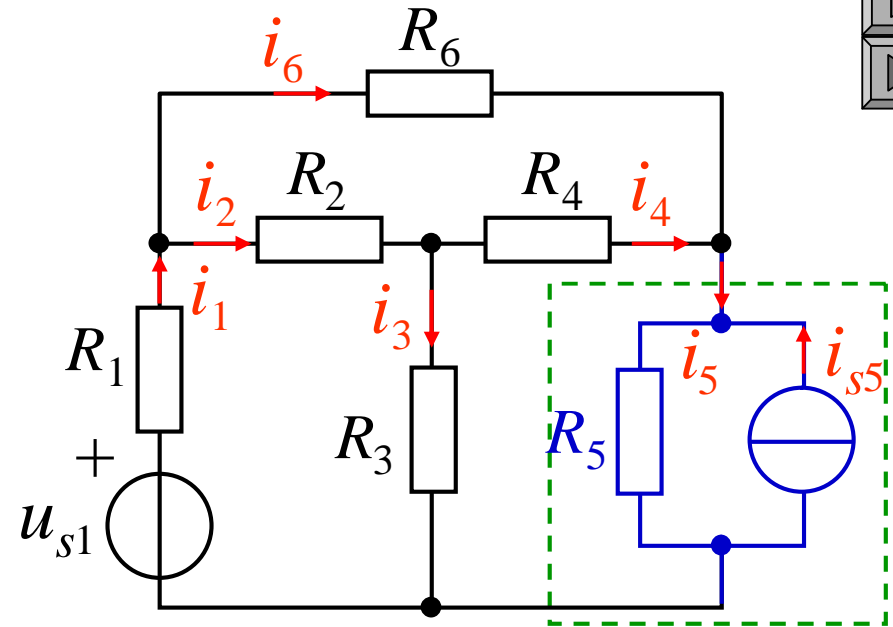

VAR

KCL KVL

1.
(1)

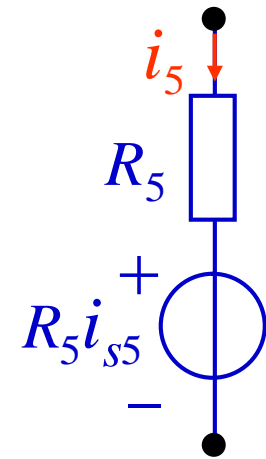

(2) KCL ($n-1$)

$$\vdots \quad -i_1 + i_2 + i_6 = 0$$

$$\vdots \quad -i_2 + i_3 + i_4 = 0$$

$$\vdots \quad -i_4 + i_5 - i_6 = 0$$

(3) ($b-n+1$)

KVL

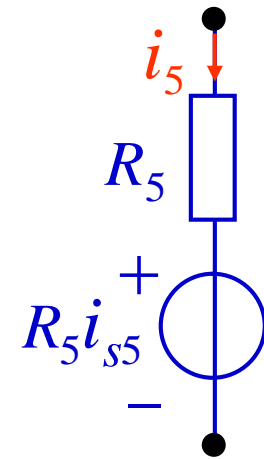
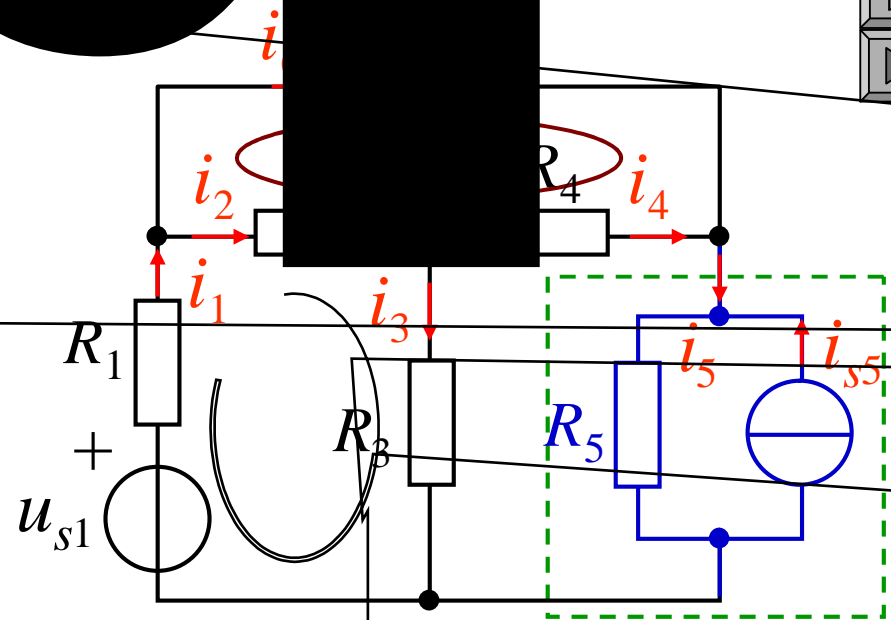

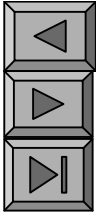

$$\begin{aligned}
 -i_1 + i_2 + i_6 &= 0 \\
 -i_2 + i_3 + i_4 &= 0 \\
 -i_4 + i_5 - i_6 &= 0 \\
 R_1 i_1 + R_2 i_2 + R_3 i_3 &= u_{s1} \\
 -R_3 i_3 + R_4 i_4 + R_5 i_5 &= -R_5 i_{s5} \\
 -R_2 i_2 - R_4 i_4 + R_6 i_6 &= 0
 \end{aligned}$$

(4) i_1 i_6

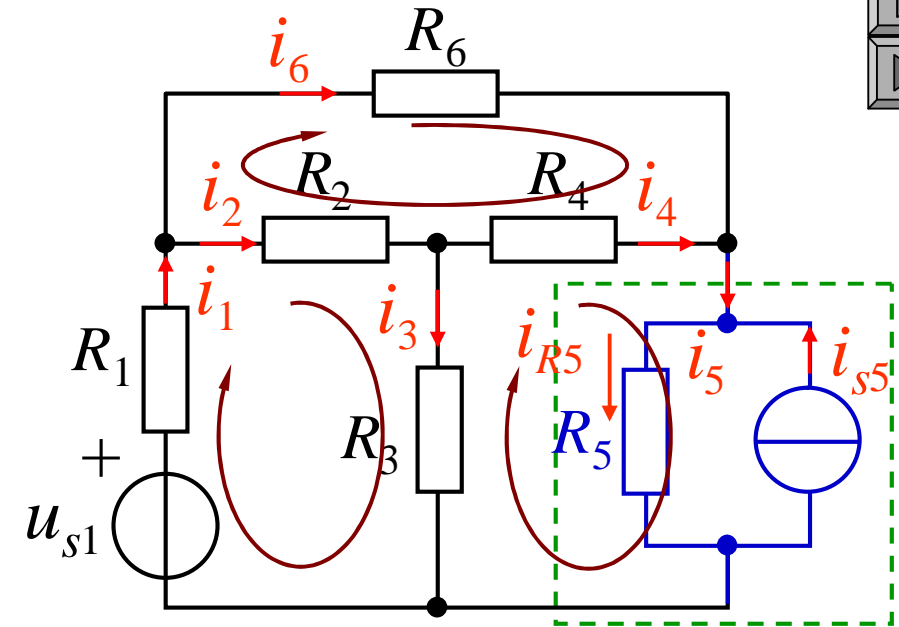

R_5

$$u_{14} = u_{s1} - R_1 i_1$$

$$i_{R5} = i_{s5} + i_5$$

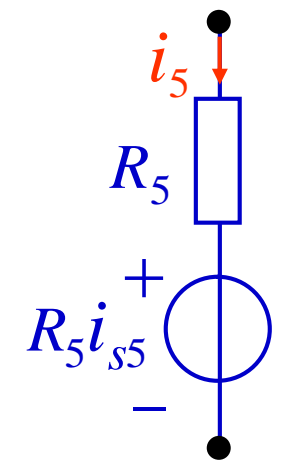



KVL

$$\begin{aligned}
 R_1 i_1 + R_2 i_2 + R_3 i_3 &= u_{s1} \\
 -R_3 i_3 + R_4 i_4 + R_5 i_5 &= -R_5 i_{s5} \\
 -R_2 i_2 - R_4 i_4 + R_6 i_6 &= 0
 \end{aligned}$$

$$R_k i_k = u_{sk}$$

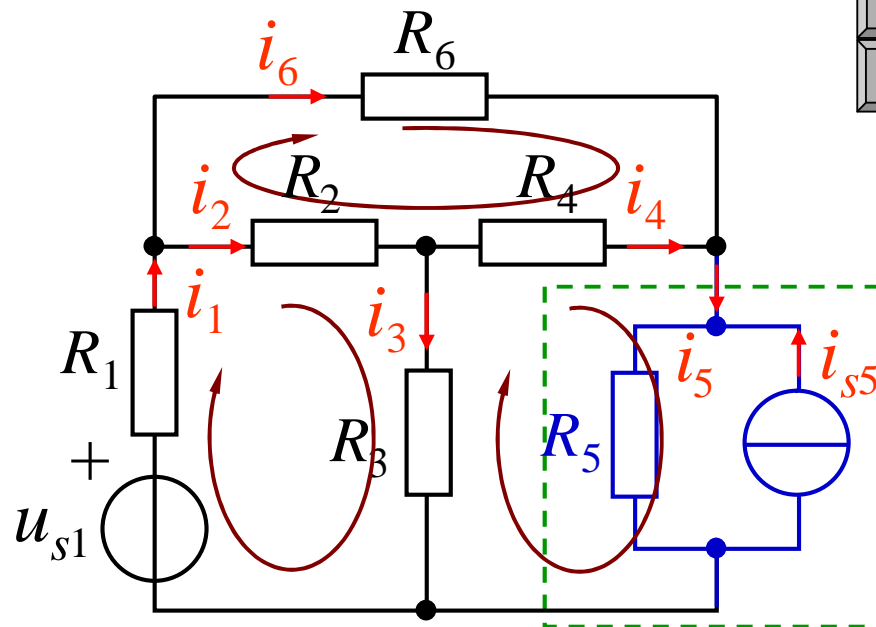

- i_k

-

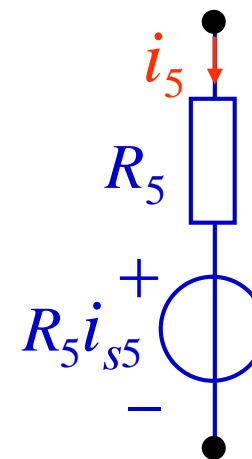
 u_{sk}
 $R_k i_k$
 u_{sk}

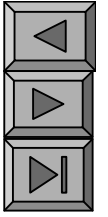

3 4



KVL

KCL

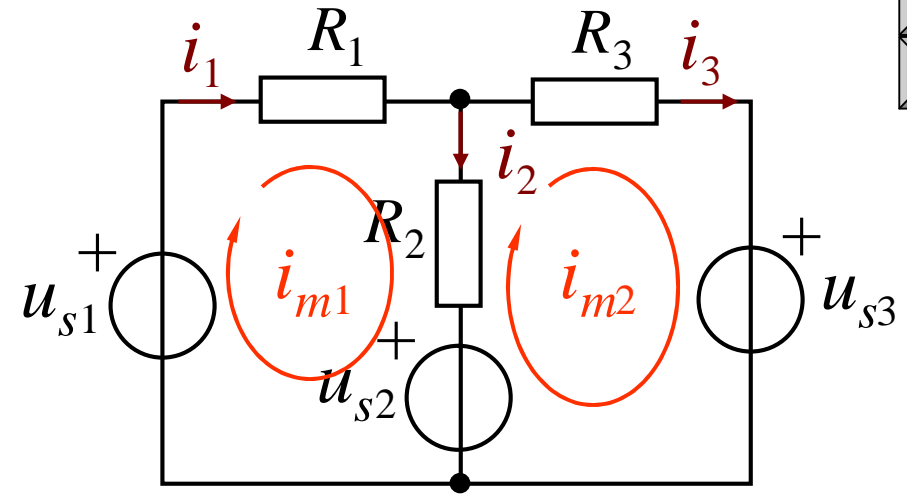
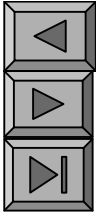

KVL

1.

(1)

(2)

KVL

i_{m1} i_{m2} R_2

$$1 \quad R_1 i_{m1} + R_2 i_{m1} - R_2 i_{m2} = u_{s1} - u_{s2}$$

$$2 \quad R_2 i_{m1} + R_2 i_{m2} + R_3 i_{m2} = u_{s2} - u_{s3}$$

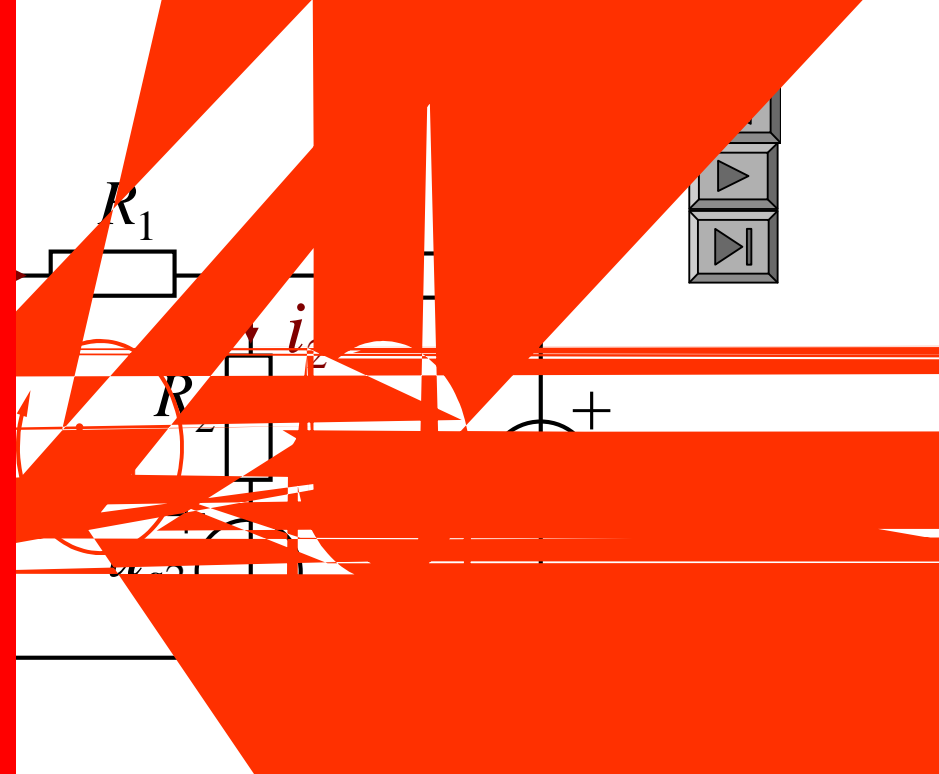

$$R_1 i_{m1} + R_2 i_{m1} \quad R_2 i_{m1} + R_2 i_{m2} + R_3 i_{m2}$$

$$(R_1 + R_2) i_{m1} \quad R_2 i_{m2} = u_{s1} - u_{s2}$$

11

$$R_2 i_{m1} + (R_2 + R_3) i_{m2} = u_{s2} - u_{s3}$$

$$R_{11}i_{m1} + R_{12}i_{m2} = u_{s11}$$

$$R_{21}i_{m1} + R_{22}i_{m2} = u_{s22}$$

$$R_{12}i_{m2} \quad i_{m2} \quad 1$$

$$R_{21}i_{m1} \quad i_{m1} \quad 2$$

$$R_{12} \quad R_{21}$$

$$i_{m2} \quad (i_{m1})$$

$$R_{12} = R_{21} = R_2$$

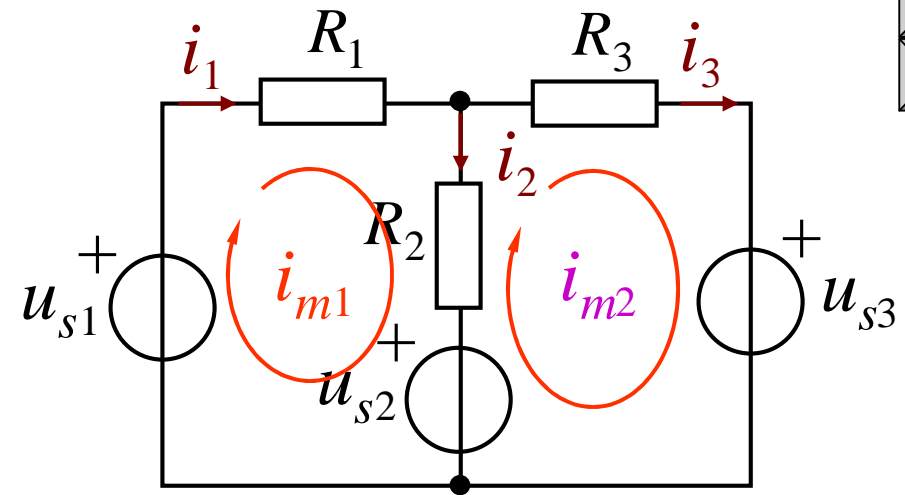

1 (2)

$$(R_1 + R_2)i_{m1} - R_2i_{m2} = u_{s1} - u_{s2}$$

$$R_2i_{m1} + (R_2 + R_3)i_{m2} = u_{s2} - u_{s3}$$

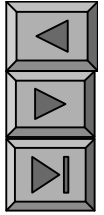

2. m

$$R_{11}i_{m1} + R_{12}i_{m2} + R_{13}i_{m3} + \dots + R_{1m}i_{mm} = u_{s11}$$

$$R_{21}i_{m1} + R_{22}i_{m2} + R_{23}i_{m3} + \dots + R_{2m}i_{mm} = u_{s22}$$

$$R_{31}i_{m1} + R_{32}i_{m2} + R_{33}i_{m3} + \dots + R_{3m}i_{mm} = u_{s33}$$

.....

$$R_{m1}i_{m1} + R_{m2}i_{m2} + R_{m3}i_{m3} + \dots + R_{mm}i_{mm} = u_{smm}$$

- R_{11} R_{mm} _____
- R_{12} R_{1m} R_{21} R_{m1}

(1)

“ ”

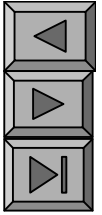

(2)

(3)

0

(4)

$$R_{ik} = R_{ki}$$

- u_{s11} u_{smm} 1 m

“+”

“ ”

3-1 (P60)

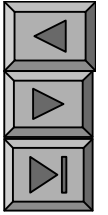

1. (T)

G

(1)

(2) G

(3)

1

2. (L)

G

(1)

(2) 2

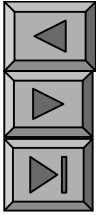

3. *KCL*

$$n-1$$

KVL

$$b - (n - 1)$$

4.

5.

P76 3 11(P77)

U_0

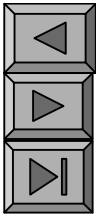

$$R_{11}=50\Omega$$

$$R_{22}=50\Omega$$

$$R_{33}=18\Omega$$

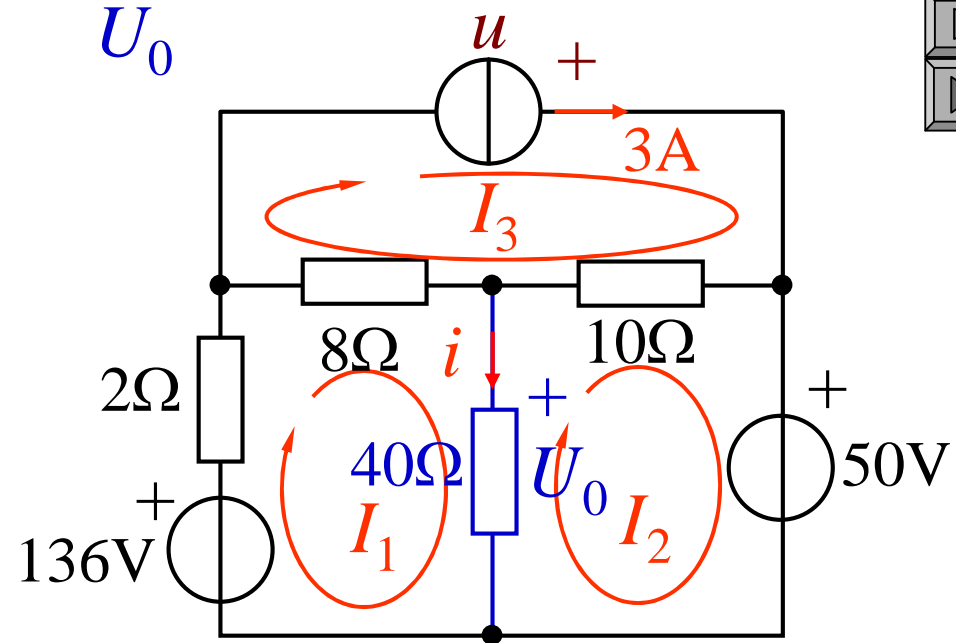
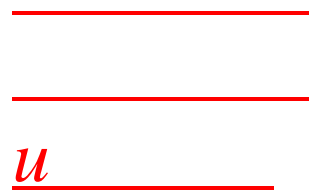

$$R_{12}=R_{21}= 40\Omega$$

$$R_{13}=R_{31}= 8\Omega$$

$$R_{23}=R_{32}= 10\Omega$$

$$\begin{cases} 50 I_1 - 40 I_2 - 8 I_3 = 136 \\ -40 I_1 + 50 I_2 - 10 I_3 = -50 \\ -8 I_1 - 10 I_2 + 18 I_3 = u \end{cases}$$

$I_3=3A$

$$I_1=8A \quad I_2=6A$$

$$\underline{\underline{U_0=40i=40(I_1 - I_2) =80V}}$$

3-5

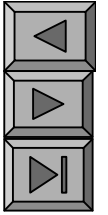

KVL



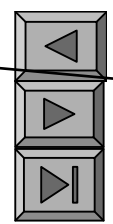

i_1 i_2 i_3

i_{l1} i_{l2} i_{l3}

$i_1 = i_{l1}$ $i_2 = i_{l2}$ $i_3 = i_{l3}$

$$i_4 = -i_{l1} + i_{l2}$$

$$i_5 = -i_{l1} - i_{l3}$$

$$i_6 = -i_{l1} + i_{l2} - i_{l3}$$

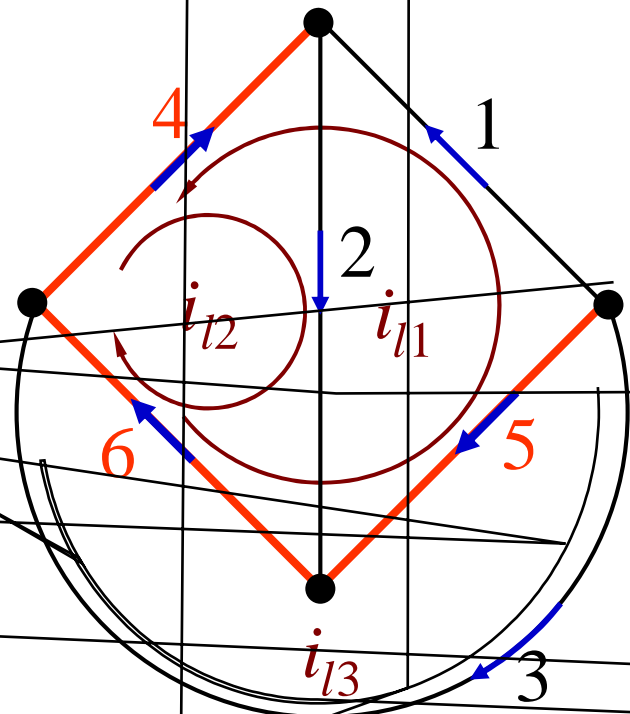

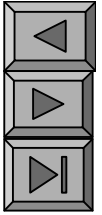

KCL

$$i_4 = -i_1 + i_2 = -i_{l1} + i_{l2}$$

$$i_5 = -i_1 - i_3 = -i_{l1} - i_{l3}$$

$$i_6 = -i_1 + i_2 - i_3 = -i_{l1} + i_{l2} - i_{l3}$$

-
-

KCL

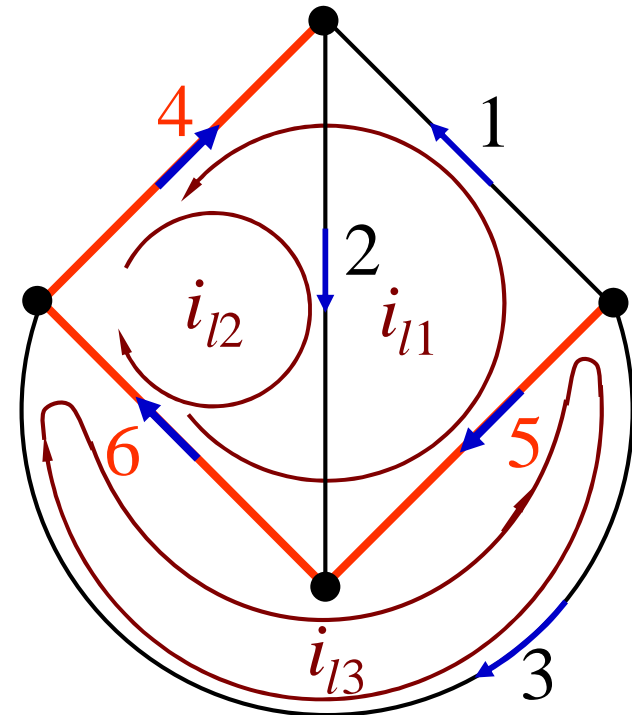

“ ”

()

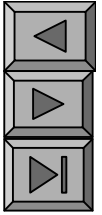

1.

- b n (\quad)
 $l = b \quad (n - 1)$ KVL

$$R_{11}i_{l1} + R_{12}i_{l2} + R_{13}i_{l3} + \dots + R_{1l}i_{ll} = u_{s11}$$

$$R_{21}i_{l1} + R_{22}i_{l2} + R_{23}i_{l3} + \dots + R_{2l}i_{ll} = u_{s22}$$

$$R_{31}i_{l1} + R_{32}i_{l2} + R_{33}i_{l3} + \dots + R_{3l}i_{ll} = u_{s33}$$

.....

$$R_{l1}i_{l1} + R_{l2}i_{l2} + R_{l3}i_{l3} + \dots + R_{ll}i_{ll} = u_{sll}$$

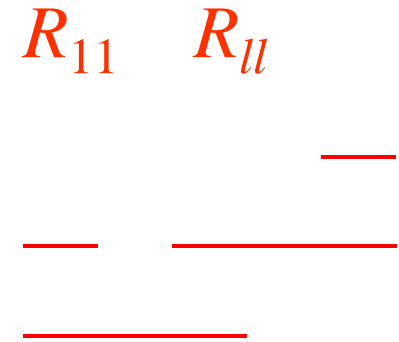

$$R_{12} \quad R_{13} \quad R_{23} \quad R_{l1} \quad R_{l1}$$

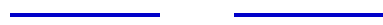

“ ”

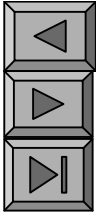

$$\begin{bmatrix} R_{11} & R_{12} & R_{13} & \cdots & R_{1l} \\ R_{21} & R_{22} & R_{23} & \cdots & R_{2l} \\ R_{31} & R_{32} & R_{33} & \cdots & R_{3l} \\ \cdots & \cdots & \cdots & \cdots & \cdots \\ R_{l1} & R_{l2} & R_{l3} & \cdots & R_{ll} \end{bmatrix} \begin{bmatrix} i_{l1} \\ i_{l2} \\ i_{l3} \\ \vdots \\ i_{li} \end{bmatrix} = \begin{bmatrix} u_{s11} \\ u_{s22} \\ u_{s33} \\ \vdots \\ u_{sll} \end{bmatrix}$$

$$u_{s11} \quad u_{sll} \quad 1 \quad l \quad 0$$

2.

P65 3 2

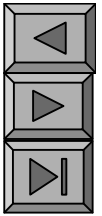
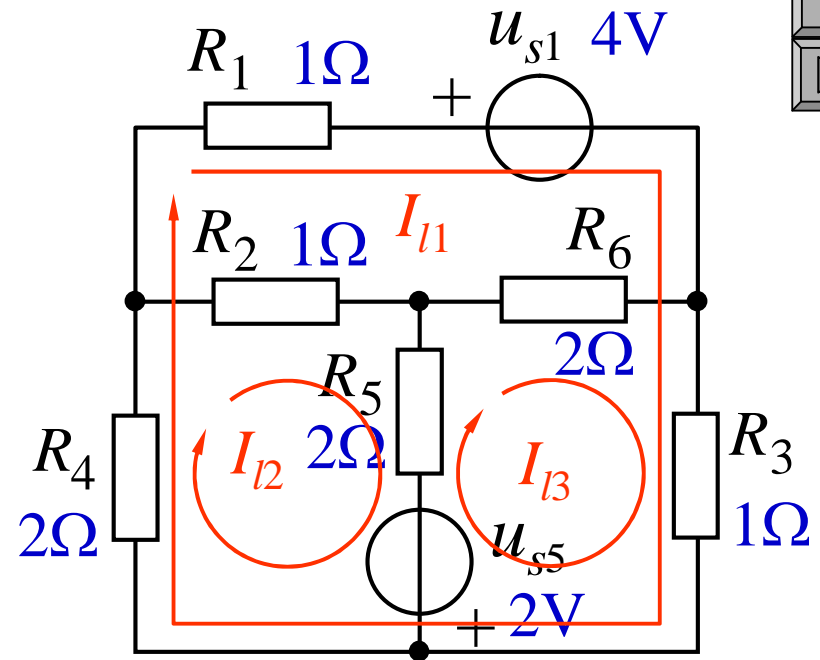

$$\left. \begin{aligned}
 \text{L1} \quad & 4I_{l1} + 2I_{l2} + 1I_{l3} = -4 \\
 \text{L2} \quad & 2I_{l1} + 5I_{l2} - 2I_{l3} = 2 \\
 \text{L3} \quad & 1I_{l1} - 2I_{l2} + 5I_{l3} = -2
 \end{aligned} \right\}$$

2.

P65

3 2

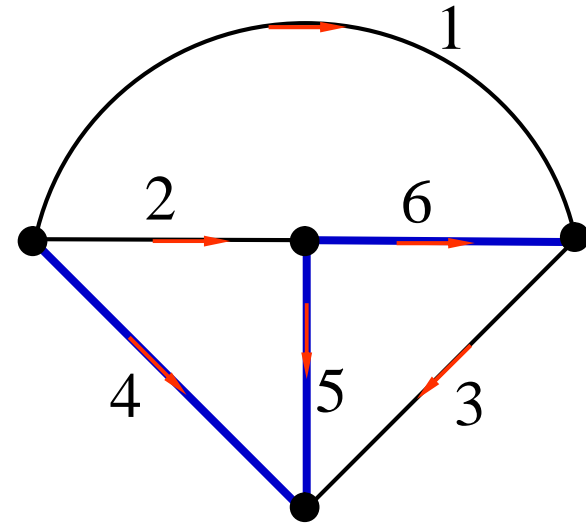
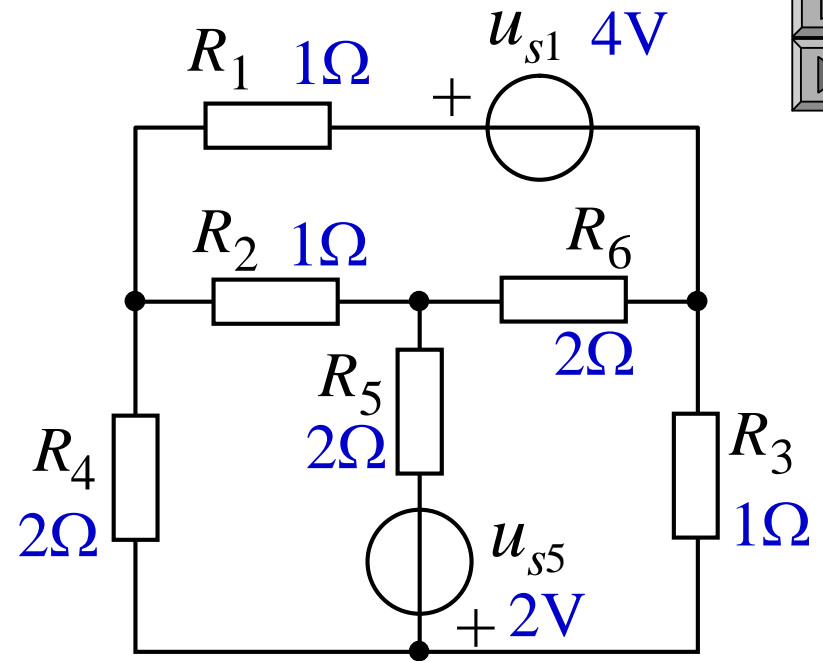
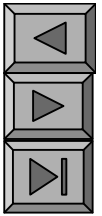

P67 3 3

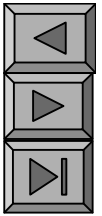

(1)

(2)

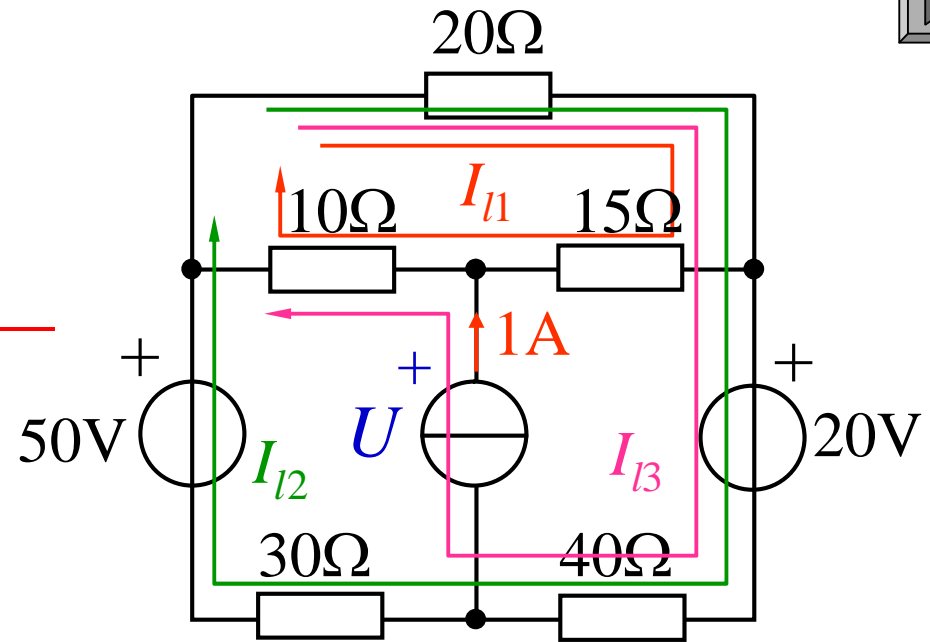

$$45I_{l1} + 20I_{l2} + 30I_{l3} = 0$$

$$20I_{l1} + 90I_{l2} + 60I_{l3} = 30$$

$$30I_{l1} + 60I_{l2} + 70I_{l3} = U - 20$$

$$I_{l3} = 1$$

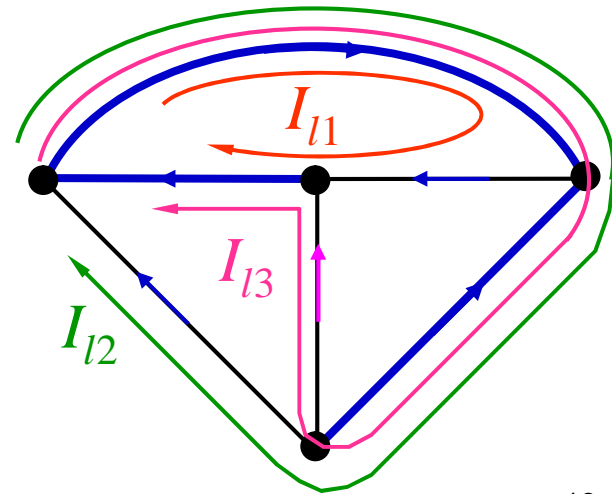

P67-68 3 4

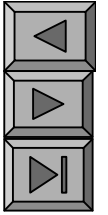

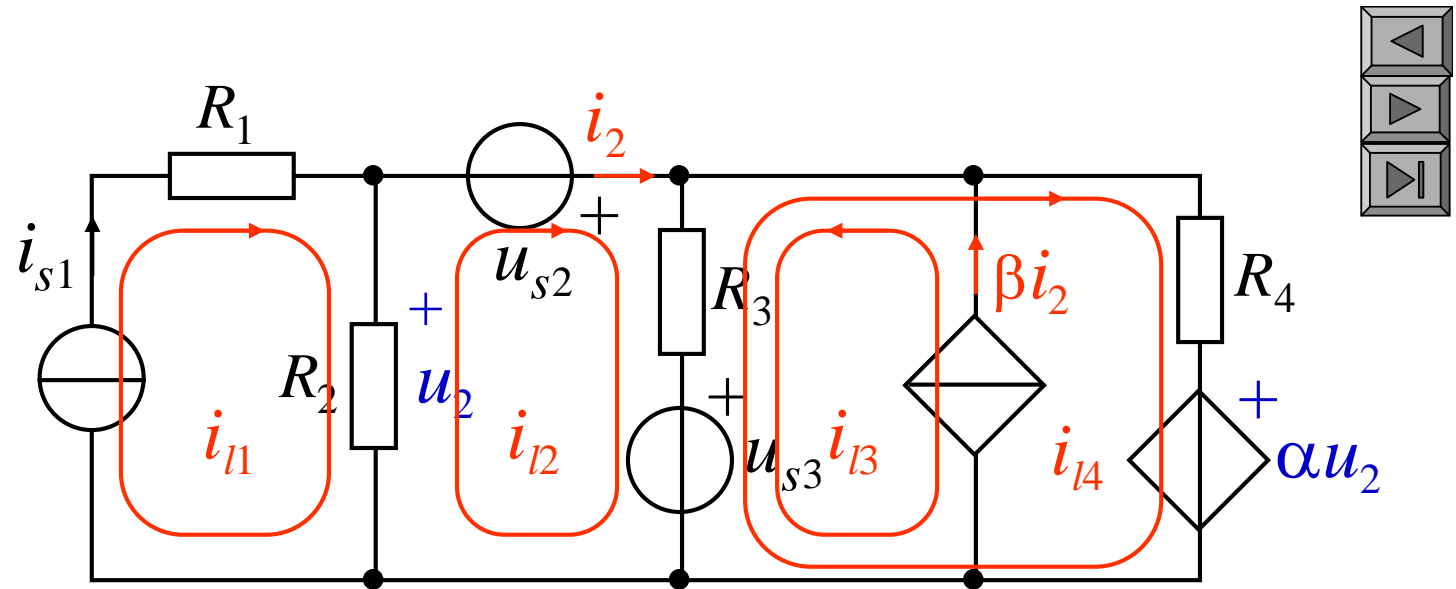

$$\text{L2} \quad \underline{-R_2 i_{l1} + (R_2 + R_3) i_{l2} + R_3 i_{l3} - R_3 i_{l4} = u_{s2} - u_{s3}}$$

$$\text{L4} \quad -R_3 i_{l2} - R_3 i_{l3} + (R_3 + R_4) i_{l4} = u_{s3} - \alpha u_2$$

1 3
KVL

$$\underline{i_{l1} = i_{s1}} \quad \underline{i_{l3} = \beta i_{l2}}$$

$$\alpha u_2 = \alpha R_2 (i_{l1} - i_{l2}) = \alpha R_2 i_{l1} - \alpha R_2 i_{l2}$$

$$\underline{\alpha R_2 i_{l1} - (\alpha R_2 + R_3) i_{l2} - R_3 i_{l3} + (R_3 + R_4) i_{l4} = u_{s3}}$$

3 6

•

•

•

n
)

$(n - 1)$

(

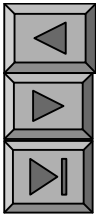
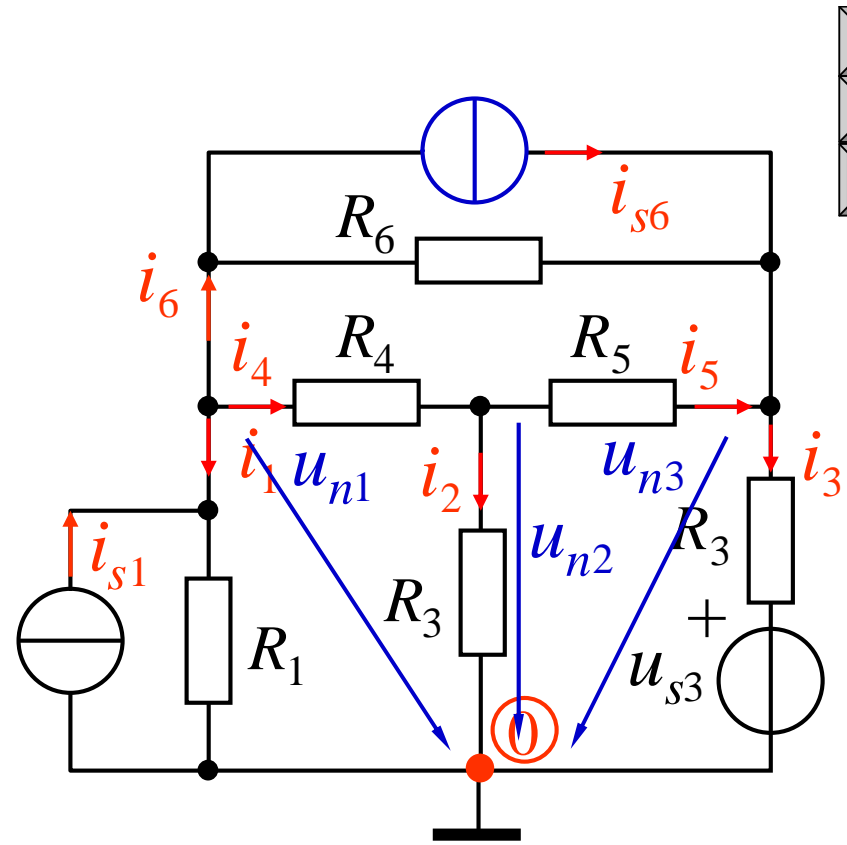



1.

•

• $u_{n1} = u_1 \quad u_{n2} = u_2 \quad u_{n3} = u_3$

•

KVL $u_1 + u_4 + u_2 = 0$

$u_4 = u_1 \quad u_2 = u_{n1} \quad u_{n2}$

$u_5 = u_{n2} \quad u_{n3}$

$u_6 = u_{n1} \quad u_{n3}$

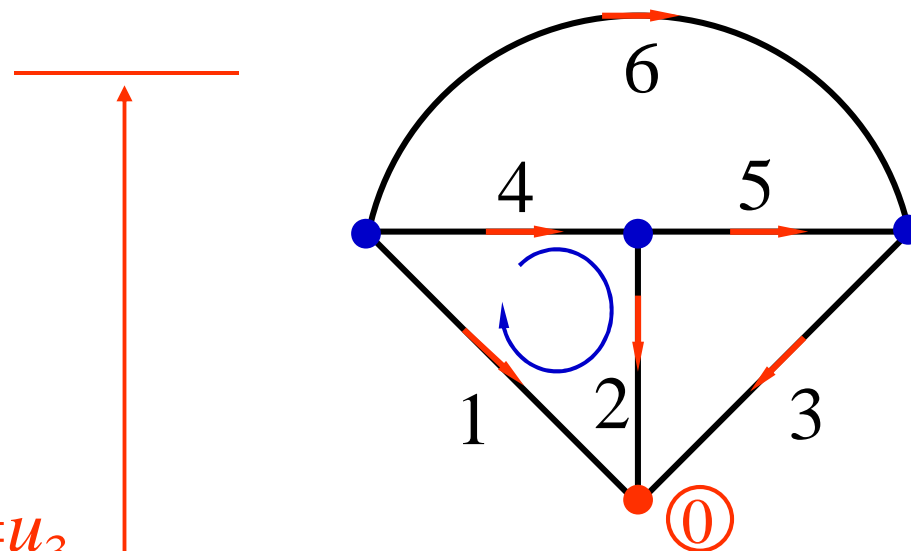

$u_1 \quad u_6$
 $u_{n1} \quad u_{n3}$

2.

KCL !

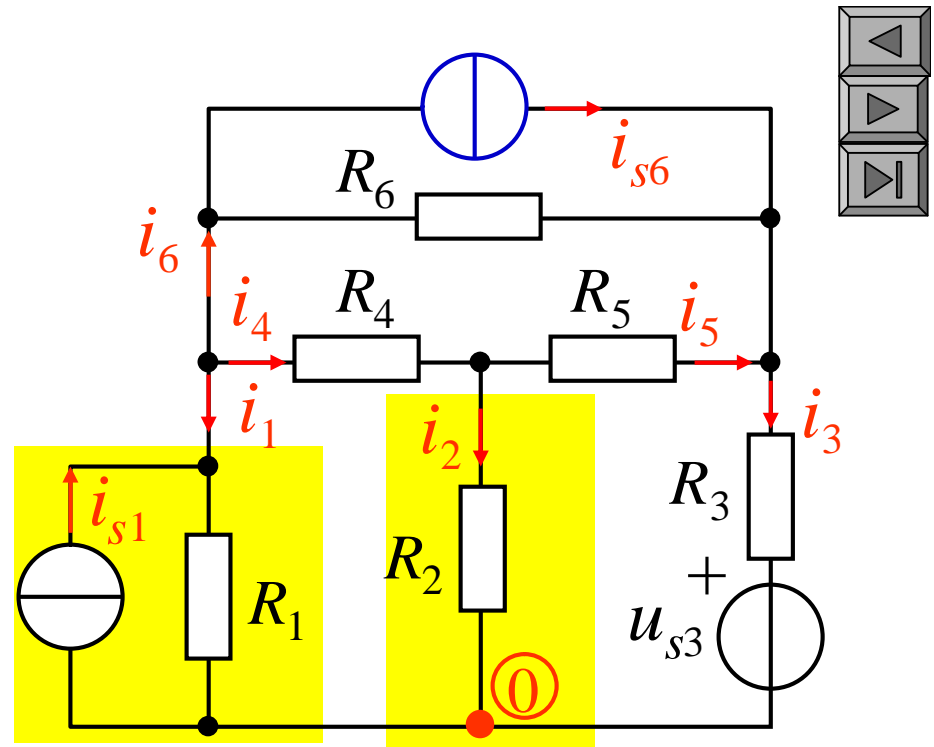

$$i_1 = \frac{u_{n1}}{R_1} - i_{s1}$$

$$i_2 = \frac{u_{n2}}{R_2}$$

$$i_3 = \frac{u_{n3} - u_{s3}}{R_3}$$

$$i_4 = \frac{u_{n1} - u_{n2}}{R_4}$$

$$i_5 = \frac{u_{n2} - u_{n3}}{R_5}$$

$$i_6 = \frac{u_{n1} - u_{n3}}{R_6} + i_{s6}$$

KCL:

$$\begin{cases} i_1 + i_4 + i_6 = 0 \\ i_2 \quad i_4 + i_5 = 0 \\ i_3 \quad i_5 \quad i_6 = 0 \end{cases}$$

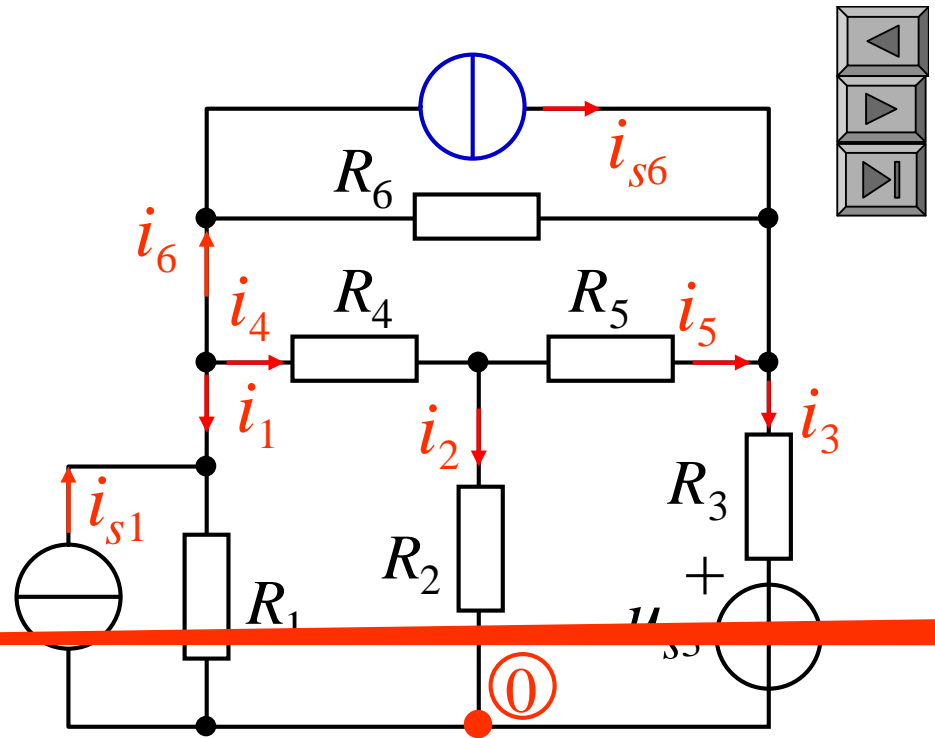

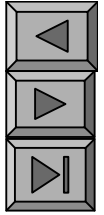

$$\left[\frac{1}{R_1} + \frac{1}{R_4} + \frac{1}{R_6} \right] u_{n1} - \frac{1}{R_4} u_{n2} - \frac{1}{R_6} u_{n3} = i_{s1} - i_{s6}$$

$$- \frac{1}{R_4} u_{n1} + \left[\frac{1}{R_2} + \frac{1}{R_4} + \frac{1}{R_5} \right] u_{n2} - \frac{1}{R_6} u_{n3} = 0$$

$$- \frac{1}{R_6} u_{n1} - \frac{1}{R_5} u_{n2} + \left[\frac{1}{R_3} + \frac{1}{R_5} + \frac{1}{R_6} \right] u_{n3} = i_{s6} + \frac{u_{s3}}{R_3}$$

$$\frac{1}{R_1} \quad \frac{1}{R_6} \quad G_1 \quad G_6$$

$$(G_1 + G_4 + G_6)u_{n1} \quad G_4 u_{n2} \quad G_6 u_{n3} = i_{s1} \quad i_{s6}$$

$$G_4 u_{n1} + (G_2 + G_4 + G_5)u_{n2} \quad G_5 u_{n3} = 0$$

$$G_6 u_{n1} \quad G_5 u_{n2} + (G_3 + G_5 + G_6)u_{n3} = i_{s6} + G_3 u_{s3}$$

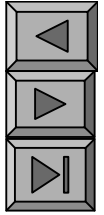

$$\begin{aligned}(G_1+G_4+G_6)u_{n1} \quad G_4u_{n2} \quad G_6u_{n3} &= i_{s1} \quad i_{s6} \\ G_4u_{n1}+(G_2+G_4+G_5)u_{n2} \quad G_5u_{n3} &= 0 \\ G_6u_{n1} \quad G_5u_{n2}+(G_3+G_5+G_6)u_{n3} &= i_{s6}+G_3u_{s3}\end{aligned}$$

$$\begin{aligned}G_{11}u_{n1}+G_{12}u_{n2}+G_{13}u_{n3} &= i_{s11} \\ G_{21}u_{n1}+G_{22}u_{n2}+G_{23}u_{n3} &= i_{s22} \\ G_{31}u_{n1}+G_{32}u_{n2}+G_{33}u_{n3} &= i_{s33}\end{aligned}$$

3.

- $G_{11} = (G_1+G_4+G_6)$

$$G_{22} = (G_2+G_4+G_5)$$

$$G_{33} = (G_3+G_5+G_6)$$

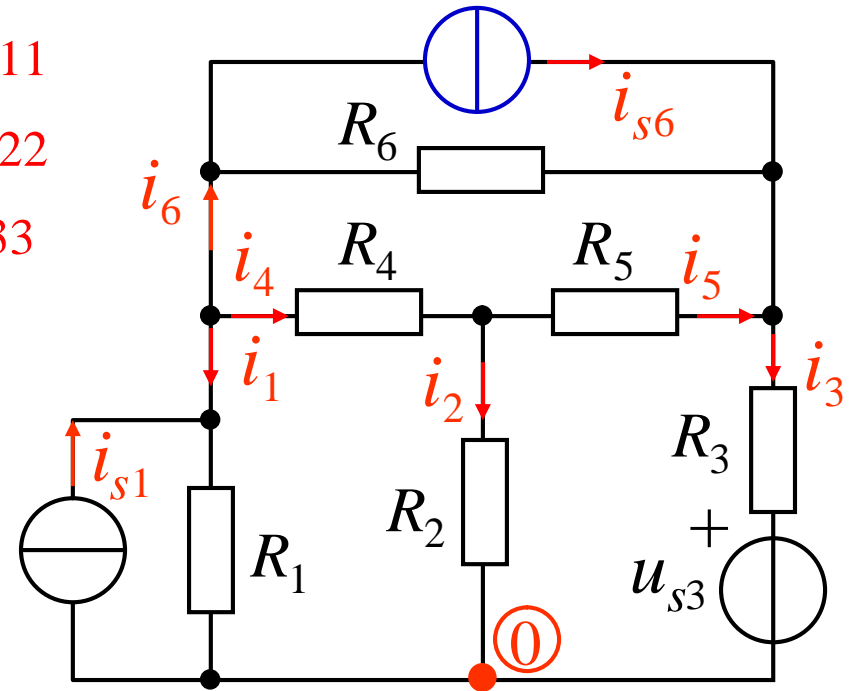

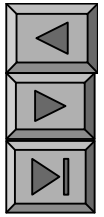

$$\begin{aligned} (G_1+G_4+G_6)u_{n1} \quad G_4u_{n2} \quad G_6u_{n3} &= i_{s1} \quad i_{s6} \\ G_4u_{n1}+(G_2+G_4+G_5)u_{n2} \quad G_5u_{n3} &= 0 \\ G_6u_{n1} \quad G_5u_{n2}+(G_3+G_5+G_6)u_{n3} &= i_{s6}+G_3u_{s3} \end{aligned}$$

$$\begin{aligned} G_{11}u_{n1}+G_{12}u_{n2}+G_{13}u_{n3} &= i_{s11} \\ G_{21}u_{n1}+G_{22}u_{n2}+G_{23}u_{n3} &= i_{s22} \\ G_{31}u_{n1}+G_{32}u_{n2}+G_{33}u_{n3} &= i_{s33} \end{aligned}$$

$$\begin{aligned} G_{12} &= G_{21} = -G_4 \\ G_{23} &= G_{32} = -G_5 \\ G_{13} &= G_{31} = -G_6 \end{aligned}$$

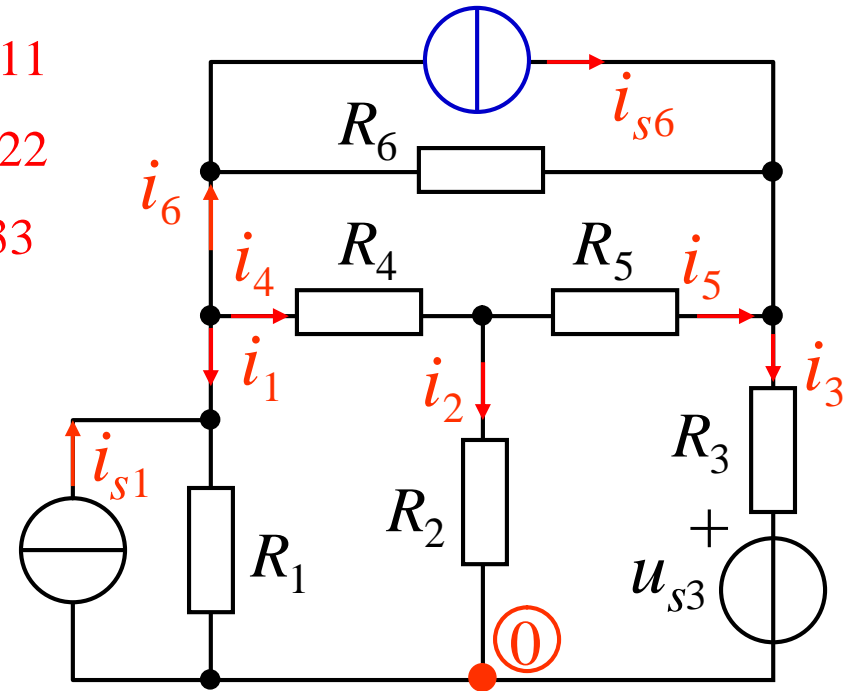

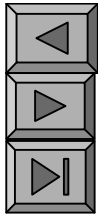

$$(G_1+G_4+G_6)u_{n1} \quad G_4u_{n2} \quad G_6u_{n3}=i_{s1} \quad i_{s6}$$

$$G_4u_{n1}+(G_2+G_4+G_5)u_{n2} \quad G_5u_{n3}=0$$

$$G_6u_{n1} \quad G_5u_{n2}+(G_3+G_5+G_6)u_{n3}=i_{s6}+G_3u_{s3}$$

$$G_{11}u_{n1}+G_{12}u_{n2}+G_{13}u_{n3}=i_{s11}$$

$$G_{21}u_{n1}+G_{22}u_{n2}+G_{23}u_{n3}=i_{s22}$$

$$G_{31}u_{n1}+G_{32}u_{n2}+G_{33}u_{n3}=i_{s33}$$

$$i_{s11}=i_{s1}-i_{s6} \quad i_{s22}=0$$

$$i_{s33}=i_{s6}-G_3u_{s3}$$

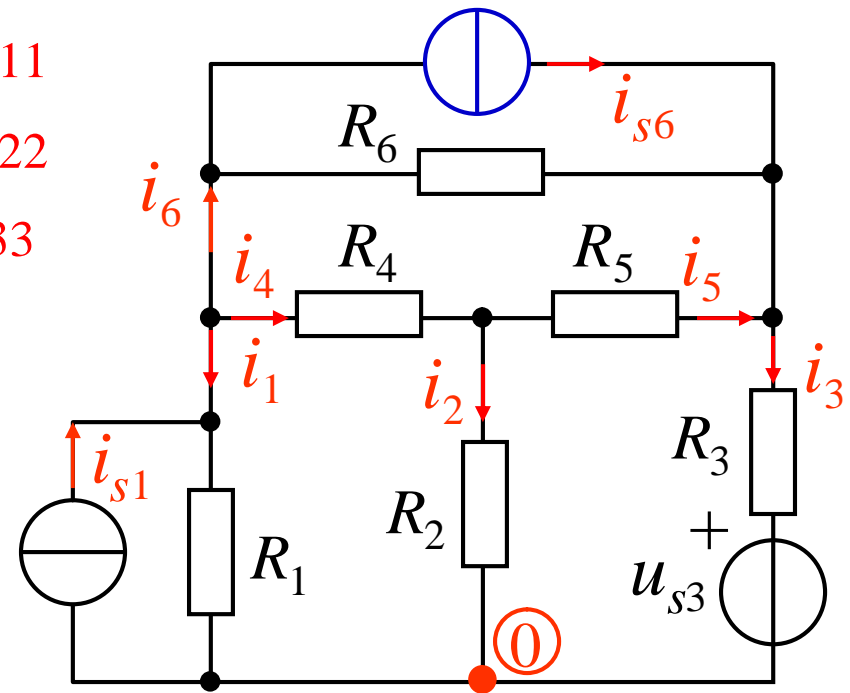

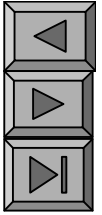

4.

- $n - 1$

$$G_{11}u_{n1} + G_{12}u_{n2} + G_{13}u_{n3} + \dots + G_{1(n-1)}u_{n(n-1)} = i_{s11}$$

$$G_{21}u_{n1} + G_{22}u_{n2} + G_{23}u_{n3} + \dots + G_{2(n-1)}u_{n(n-1)} = i_{s22}$$

$$G_{31}u_{n1} + G_{32}u_{n2} + G_{33}u_{n3} + \dots + G_{3(n-1)}u_{n(n-1)} = i_{s33}$$

.....

$$G_{(n-1)1}u_{n1} + G_{(n-1)2}u_{n2} + G_{(n-1)3}u_{n3} + \dots + G_{(n-1)(n-1)}u_{n(n-1)} = i_{s(n-1)(n-1)}$$

-

$$G_{ij} = G_{ji}$$

P71 3 5

①

$$\begin{aligned}
 & : (G_1 + G_4 + G_8)u_{n1} \\
 -G_1 u_{n2} - G_4 u_{n4} & = i_{s4} - i_{s13} \\
 & : (G_1 + G_2 + G_5)u_{n2} \\
 -G_1 u_{n1} - G_2 u_{n3} & = 0 \\
 & : (G_2 + G_3 + G_6)u_{n3} \\
 -G_2 u_{n2} - G_3 u_{n4} & = i_{s13} - G_3 u_{s3} \\
 & : (G_3 + G_4 + G_7)u_{n4} - G_4 u_{n1} - G_3 u_{n3} \\
 & = G_3 u_{s3} + G_7 u_{s7} - i_{s4}
 \end{aligned}$$

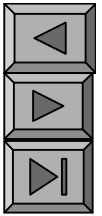
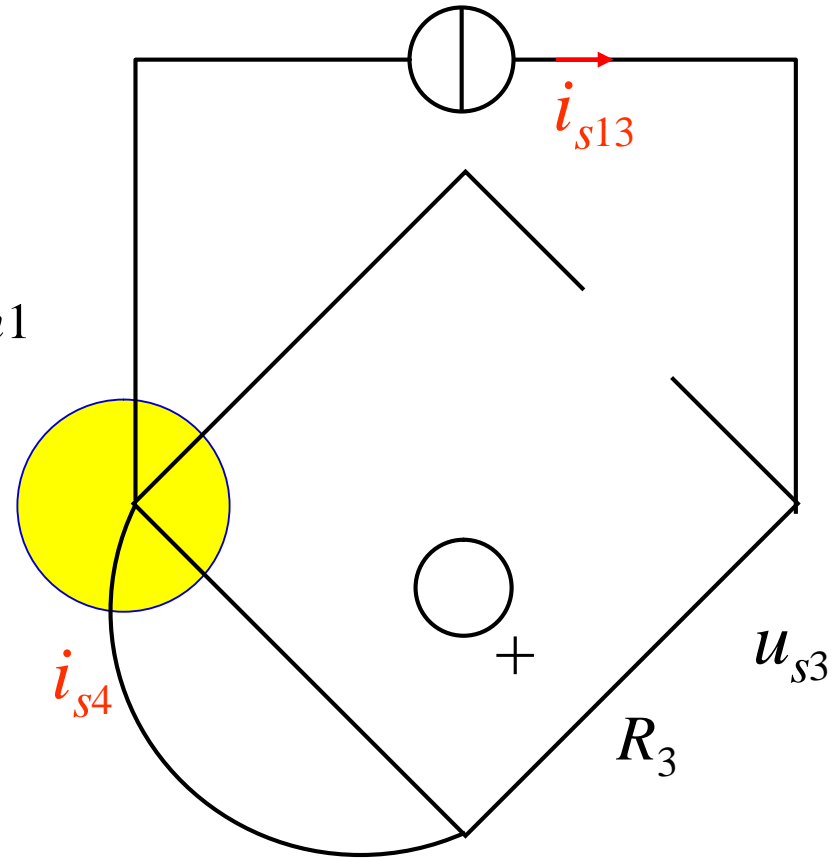

3 6 ()

5.

P73 3 7

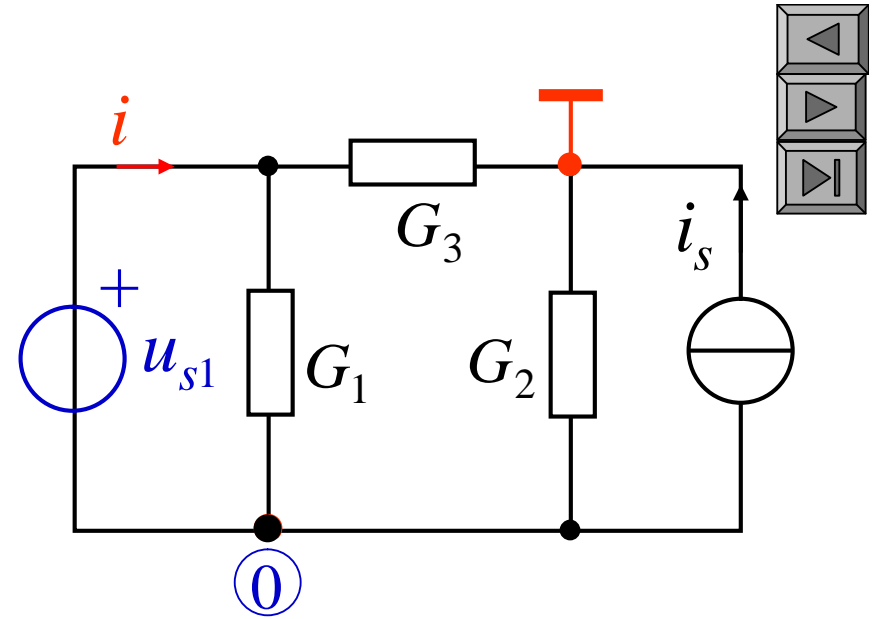

$$(G_1 + G_3)u_{n1} - G_3u_{n2} = i$$

$$-G_3u_{n1} + (G_2 + G_3)u_{n2} = i_{s2}$$

$$u_{n1} = u_{s1}$$

$$u_{s1}$$

$$u_{n1} = u_{s1}$$

$$u_{n2}$$

$$(G_1 + G_3)u_{n1} - G_1u_{n0} = i$$

$$-G_1u_{n1} + (G_1 + G_2)u_{n0} = -i_{s2} - i$$

$$u_{n1} - u_{n0} = u_{s1}$$

3 7

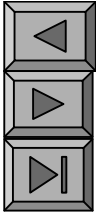

6.

P74 3 8

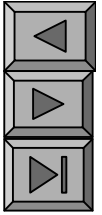

(1)

“0”

$$u_{n1} = u_2$$

(2)

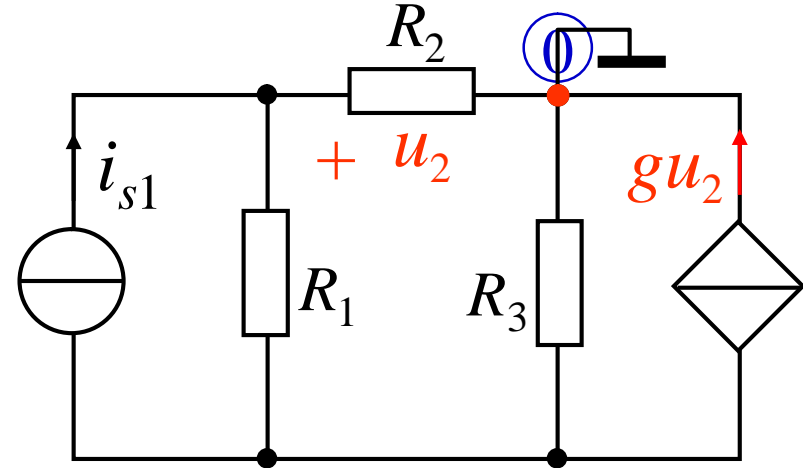

$$\therefore \left(\frac{1}{R_1} + \frac{1}{R_2} \right) u_{n1} - \frac{1}{R_1} u_{n2} = i_{s1} \quad (3)$$

$$\therefore \left(\frac{1}{R_2} + \frac{1}{R_3} \right) u_{n2} = -i_{s1} - g u_{n1}$$

$$\left(-\frac{1}{R_1} + g \right) u_{n1}$$

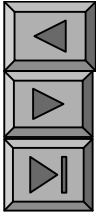

1. (“-”)

2. :

3.

4.

